

Malfunction Abatement Plan



Holland Energy Park – Fire Pump Engine

Holland Board of Public Works
625 Hastings Avenue
Holland, MI 49423



NTH Project No. 74-180253-01
November 9, 2018

NTH Consultants, Ltd.
608 S. Washington Ave.
Lansing, MI 48933

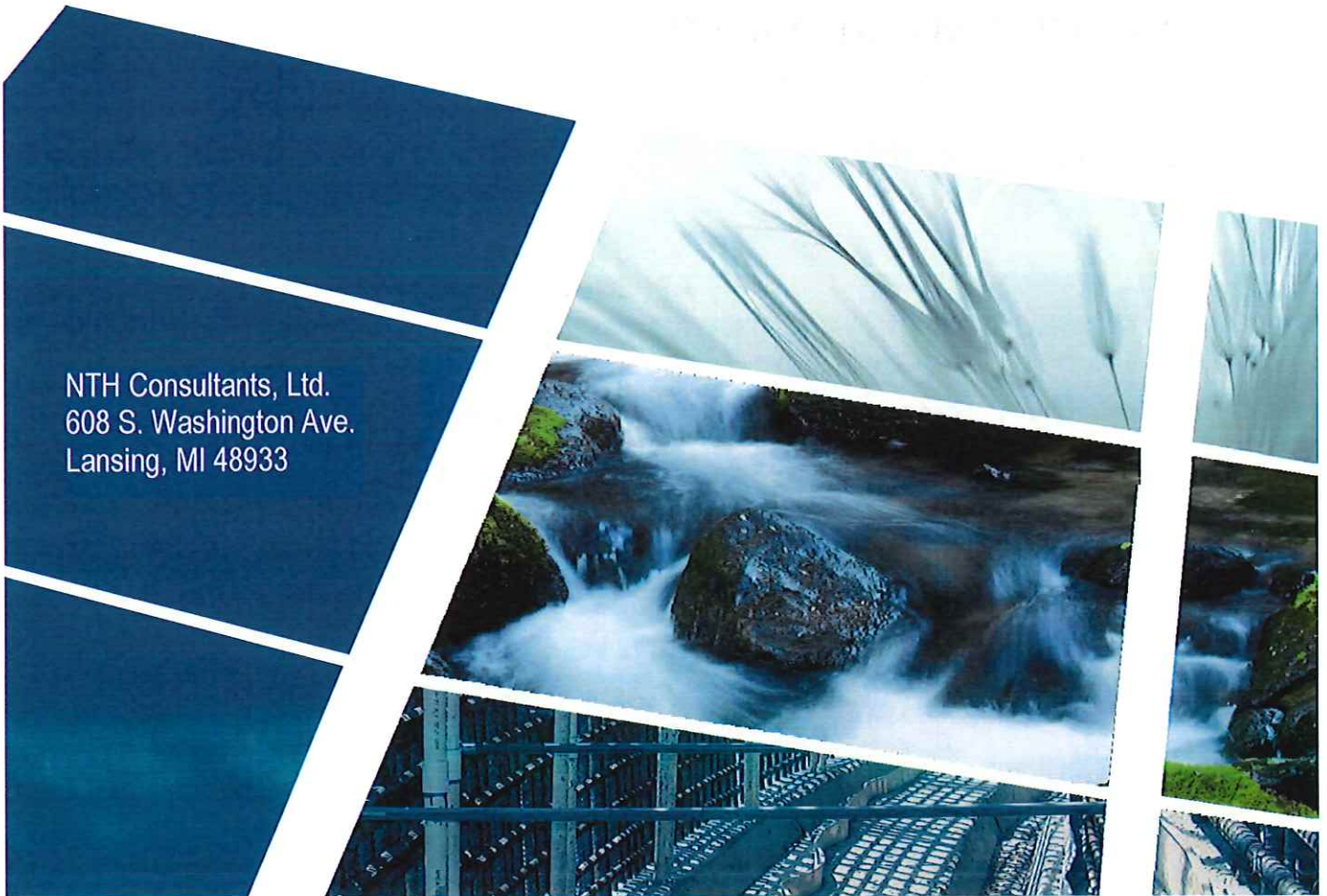

✓



TABLE OF CONTENTS

1.0	INTRODUCTION	1
1.1	Purpose of the Plan	1
2.0	MALFUNCTION ABATEMENT PLAN	2
2.1	Malfunction Abatement Plan Requirements	2
2.2	Preventative Maintenance Program	3
3.0	RECORDKEEPING REQUIREMENTS	4
4.0	REPORTING REQUIREMENTS	4
4.1	Michigan Air Pollution Control Rule 912	5
5.0	PLAN REVISIONS	6

APPENDICES

APPENDIX A – FIRE PUMP ENGINE OPERATION & MAINTENANCE MANUAL

APPENDIX B – ENGINE READINESS TEST PROCEDURES



1.0 INTRODUCTION

Holland Board of Public Works (BPW) operates the Holland Energy Park (HEP) in accordance with Renewable Operating Permit (ROP) No. MI-ROP-Po465-2018. HEP is a natural gas-fired combined heat and power (CHP) plant located at 1 Energy Park Way in Holland, Michigan. ROP No. MI-ROP-Po465-2018 includes a requirement to submit a Malfunction Abatement Plan (MAP) in EUPENGINE Special Condition III.6 for HEP's emergency diesel fire pump engine, identified as EUPENGINE, within 180 days of ROP issuance.

EUPENGINE is a certified diesel-fired emergency engine that is used for fire suppression during an emergency at HEP, and has a nameplate capacity of 144 horsepower (hp). The engine model number of EUPENGINE is JU4H-UFADW8.

1.1 Purpose of the Plan

Michigan Air Pollution Control Rule 911 requires, at the request of the Michigan Department of Environmental Quality (MDEQ), a source of an air contaminant to operate under a MAP. The purpose of a MAP is to document preventative measures of equipment malfunctions and/or failures that result in pollutant emissions above applicable emission limitations, as well as procedures to detect and correct these incidents when they occur.

Sections 2.0 of this plan details the MAP requirements for EUPENGINE. Sections 3.0 and 4.0 contain recordkeeping and reporting requirements. Sections 5.0 contains a list of plan revisions. Appendices A and B contain pertinent information related to this MAP, as obtained from the Operation and Maintenance Instructions Manual for Fire Pump Applications ("Fire Pump Manual") prepared by Clarke Fire Protection Products, Inc..



2.0 MALFUNCTION ABATEMENT PLAN

For the purposes of this MAP, a malfunction is defined pursuant to Part 1 of the Michigan Air Pollution Control Rules:

Malfunction means any sudden, infrequent and not reasonably preventable failure of a source, process, process equipment, or air pollution control equipment to operate in a normal or usual manner. Failures that are caused in part by poor maintenance or careless operation are not malfunctions.

In the event of a malfunction of EUPENGINE, BPW will follow the procedures in this plan for proper operation in order to minimize excess emissions. This MAP is intended to provide a roadmap to plant operations, and outlines procedures for operation of EUPENGINE during malfunction events. This plan will ensure that:

- During malfunction events, BPW operates and maintains EUPENGINE in a manner consistent with good air pollution control practices;
- BPW is prepared to correct malfunctions as soon as it is safe and practicable to do so, in order to minimize excess emissions of air pollutants; and
- BPW meets the recordkeeping and reporting requirements associated with periods of malfunction events (including documenting corrective action taken to restore malfunctioning process and air pollution control equipment to its usual manner of operation).

2.1 Malfunction Abatement Plan Requirements

Pursuant to Michigan Rule 911, a MAP must specify the following:



- A complete preventative maintenance program, including identification of the supervisory personnel responsible for overseeing the inspection, maintenance, and repair of air-cleaning devices, a description of the items or conditions that shall be inspected, the frequency of the inspections or repairs, and an identification of the major replacement parts for quick replacement.
- An identification of the source and air-cleaning device operating variables that shall be monitored to detect a malfunction or failure, the normal operating range of these variables, and a description of the method of monitoring or surveillance procedures.
- A description of the corrective procedures or operational changes that shall be taken in the event of a malfunction or failure to achieve compliance with the applicable emission limits.

2.2 Preventative Maintenance Program

EUFENGINE and associated monitoring equipment must be operated by qualified individuals. The Maintenance Supervisor and Operations Supervisor will collectively be responsible for overseeing the inspection, maintenance, and repair of EUFPENGINE, ongoing training of personnel in charge of operations, and monitoring of equipment to ensure EUFPENGINE is functioning properly.

HEP personnel will conduct scheduled maintenance, testing, and inspections on the engine at manufacturer recommended intervals. Section 4.0 of the Fire Pump Manual, contained in Appendix A, provides the maintenance schedule. The Fire Pump Manual also outlines maintenance and service procedures, as well as proper equipment/part conditions, related to various maintenance activities. HEP will also perform a monthly readiness test on EUFPENGINE as outlined in Appendix B. Records of maintenance, testing, and inspections will be properly documented.



A list of spare parts for repairs and maintenance on the engine is contained in Appendix A of the enclosed Fire Pump Manual.

EUFENGINE contains an Electronic Control Module (ECM) that controls the engine's functions, including monitoring and protection of engine operation. If an engine parameter surpasses an acceptable range, the ECM initiates a warning or a shutdown, and a diagnostic trouble code (DTC) is stored in the ECM's memory. The engine monitoring system monitors specific parameters, and the ECM will activate a warning if their associated trip points are reached. The list of DTCs are contained in Section 5.0 of the enclosed Fire Pump Manual. Corrective action will be taken to bring the engine parameters back into their normal ranges.

3.0 RECORDKEEPING REQUIREMENTS

Pursuant to ROP No. MI-ROP-Po645-2018 for EUFPENGINE, the MAP shall address events that meet the characteristics of a malfunction and specify information contained in Michigan Rule 911. BPW will keep a copy of the MAP onsite, and will maintain records of testing, maintenance, and malfunction events in plant work orders, including the time, date, probable cause(s), duration, affected equipment, emission estimates, and the corrective actions taken in response to the malfunction. Records are to be provided to BPW's Environmental Department, and maintained in accordance with BPW's records retention policy.

4.0 REPORTING REQUIREMENTS

This section covers various reporting requirements related to the MAP.



4.1 Michigan Air Pollution Control Rule 912

Michigan Rule 912 requires that a facility operate its source, process, or process equipment, to the extent that is reasonably possible, in a manner consistent with good air pollution control practices for minimizing emissions during periods of abnormal conditions, startup, shutdown, and malfunctions. A source, process, or process equipment that complies with all applicable emission standards and limitations during periods of abnormal conditions, startup, shutdown, and malfunction shall be presumed to have been operated in a manner consistent with good air pollution control practices for minimizing emissions.

ROP No. MI-ROP-P0465-2018 contains emission limits for EUPENGINE for oxides of nitrogen (NO_x), carbon monoxide (CO), particulate matter (PM, PM₁₀, PM_{2.5}), volatile organic compounds (VOC) and Greenhouse Gases (GHGs) as carbon dioxide equivalent (CO₂e) during normal operation. Pursuant to Rule 912, BPW will provide notice and a written report of a malfunction when excess emissions above the emission limitations for EUPENGINE occur for more than two (2) hours. The requirements for notices and written reports are as follows:

- The notices required shall be provided to MDEQ as soon as reasonably possible, but not later than two (2) business days after the discovery of the abnormal conditions or malfunction. Notice shall be by any reasonable means, including electronic, telephonic, or oral communication.
- Written reports, if required, must be submitted to MDEQ within 10 days after the abnormal conditions or malfunction has been corrected, or within 30 days of discovery of the abnormal condition or malfunction, whichever is first. The truth, accuracy, and completeness of the written reports shall be certified by a responsible official in a manner consistent with the Clean Air Act. The written reports shall include all of the required information:



- The time and date, the probable causes or reasons for, and the duration of the abnormal conditions or malfunction.
- An identification of the source, process, or process equipment that experienced abnormal conditions or which malfunctioned, and all other affected process or process equipment that have emissions in excess of an applicable requirement, including a description of the type and, where known or where it is reasonably possible to estimate, the quantity or magnitude of emissions in excess of applicable requirements.
- Information describing the measures taken and air pollution control practices followed to minimize emissions.
- For abnormal conditions and malfunctions, the report shall also include a summary of the actions taken to correct and to prevent a reoccurrence of the abnormal conditions or malfunction and the time taken to correct the malfunction.

5.0 PLAN REVISIONS

The MAP will be revised to address reasonable revision requests by MDEQ. Revisions may be requested if it is determined that the plan:

- Does not address a malfunction event that has occurred.
- Fails to provide operation of EUPENGINE in a manner consistent with the general duty to minimize emissions during malfunction events.
- Inadequately addresses provisions for correcting malfunctioning process or emission control equipment.

A current copy of the plan will be sent to MDEQ. A copy will also be kept on file by BPW (in paper or electronic form) for the life of EUPENGINE.



Table 5-1. MAP Revision History

Date Issued	Revision #	Revised by	Summary of Changes
11/09/2018	0	Not Applicable	Original Version

APPENDIX



// Fire Pump Engine Operation &
Maintenance Manual

Operation and Maintenance Instructions Manual

JU/JW/JX MODELS ELECTRONIC ENGINES FOR FIRE PUMP APPLICATIONS

This manual covers John Deere Engines
Prepared by Clarke
for fire pump service

Clarke UK, Ltd.
Unit 1, Grange Works
Lomond Road
Coatbridge
ML5 2NN
United Kingdom
TELE: +44(0)1236 429946
FAX: +44(0)1236 427274

Clarke Fire Protection Products, Inc.
100 Progress Place
Cincinnati, OH 45246
U.S.A.

TELE: +1.513.771.2200 Ext. 427
FAX: +1.513.771.5375

www.clarkefire.com

C132678
3/17
RevAA

CONTENTS

SUBJECT	PAGE
1.0 INTRODUCTION	6
1.1 IDENTIFICATION/NAMEPLATE	6
1.2 SAFETY/CAUTION/WARNINGS	7
1.3 PRECAUTIONS FOR WELDING	11
2.0 INSTALLATION/OPERATION	11
2.1 TYPICAL INSTALLATION	11
2.2 ENGINE STORAGE	12
2.2.1 Storage Less than 1 year	12
2.2.2 Extended Storage Maintenance Procedure	12
2.3 INSTALLATION INSTRUCTIONS	12
2.4 SPECIFIC FLYWHEEL COUPLING ALIGNMENT INSTRUCTIONS	14
2.4.1 Driveshaft	14
2.4.2 Falk "Steelflex" Coupling	16
2.5 WEEKLY TEST	16
2.6 STARTING/STOPPING THE ENGINE	16
2.6.1 To Start Engine	16
2.6.2 To Stop Engine	17
2.6.3 Describing Engine Gauge Panel	19
2.6.3.1 ECM Selector Switch and Primary/Alternate Electronic Control Modules (ECM's)	19
2.6.3.2 Dual ECM Automatic Switching	19
2.6.3.3 Using Power View Gauge	20
3.0 ENGINE SYSTEMS	29
3.1 FUEL SYSTEM	29
3.1.1 Diesel Fuel Specification	29
3.1.2 Bleeding the Fuel System	30
3.1.2.1 JU4/6 Engine Series	31
3.1.2.2 JW6 Engine Series	32
3.1.2.3 JX6 Engine Series	32
3.1.3 Changing Fuel Filter Cartridge	32
3.1.3.1 JU4/6 Engine Series	32
3.1.3.2 JW6 Engine Series	33
3.1.3.3 JX6 Engine Series	34
3.1.4 Restarting Engine Which Has Run Out of Fuel	36
3.1.5 Fuel Tanks	38
3.2 AIR/EXHAUST SYSTEM	38
3.2.1 Ambient Conditions	38
3.2.2 Ventilation	38
3.2.3 Standard Air Filter	38
3.2.4 Crankcase Ventilation	40
3.2.5 Exhaust System	40
3.3 LUBRICATION SYSTEM	41

3.3.1	Checking Sump Oil.....	41
3.3.2	Changing Engine Oil.....	42
3.3.3	Changing Oil Filter Cartridge.....	42
3.3.4	Oil Specification.....	42
3.3.5	Oil Capacities.....	42
3.4	COOLING SYSTEM.....	42
3.4.1	Intended Engine Operating Temperature.....	42
3.4.2	Engine Coolant	42
3.4.3	Water.....	43
3.4.4	Coolant Capacities.....	43
3.4.5	Coolant Inhibitors.....	43
3.4.6	Procedure for Filling Engine.....	44
3.4.7	Providing Adequate Raw Water Supply to the Engine Heat Exchanger.....	44
3.4.7.1	Raw Water Supply.....	44
3.4.7.2	Cooling Loop.....	45
3.4.7.3	Setting Raw Water Flow Rate.....	46
3.4.7.4	Raw Water Outlet.....	46
3.4.7.5	Raw Water Quality Strainers and Deterioration of Heat Exchanger (CAC).....	47
3.4.7.6	Backflow Preventers.....	47
3.4.7.7	Raw Water Outlet Temperature.....	47
3.4.8	Flow Paths of Engine Cooling System.....	47
3.4.9	Important Service Notice.....	48
3.4.9.1	Water Pump Cavitation.....	49
3.5	ELECTRICAL SYSTEM.....	49
3.5.1	Wiring Diagrams.....	49
3.5.2	Checking Drive Belt Tension and Adjustment.....	49
3.5.3	Engine Overspeed.....	49
3.5.4	Field Simulation of Pump Controller Alarms.....	50
3.5.5	Battery Requirements.....	50
3.6	ENGINE SPEED ADJUSTMENT.....	50
4.0	MAINTENANCE SCHEDULE.....	51
4.1	ROUTINE MAINTENANCE.....	51
5.0	TROUBLE SHOOTING.....	51
5.1	DIAGNOSTIC TROUBLE CODES.....	52
6.0	PARTS INFORMATION.....	53
6.1	SPARE PARTS.....	53
6.2	ENGINE MAINTENANCE PARTS LIST.....	53
7.0	OWNER ASSISTANCE.....	53
8.0	WARRANTY.....	53
8.1	GENERAL WARRANTY STATEMENT.....	53
8.2	CLARKE WARRANTY.....	54

8.3 JOHN DEERE WARRANTY.....	54
9.0 INSTALLATION & OPERATION DATA (See Page 5).....	56
10.0 WIRING DIAGRAMS (See Page 5).....	56
11.0 PARTS ILLUSTRATION & DRAWINGS (See Page 5).....	56
12.0 KEYWORD INDEX.....	57
13.0 APPENDIX "A".....	58

Check factory availability for a manual in one of the following languages:

Spanish	German	French	Italian
---------	--------	--------	---------

NOTE

The information contained in this book is intended to assist operating personnel by providing information on the characteristics of the purchased equipment. It does not relieve the user of their responsibility of using accepted practices in the installation, operation, and maintenance of the equipment.

NOTE: CLARKE FPPG Reserves the right to update the contents of this publication without notice.

Technical Catalog Discontinuation Notice

Effective January 2015,

Clarke has done away with the Technical Catalogs. The Technical Catalogs consisted of the following technical documents:

- Model Specific Installation and Operations Data (I&O)
- NFPA20 Cooling Loop C13977
- NFPA20 Lead Acid Battery Specifications C131885
- NFPA20 Exhaust Piping C06918
- NFPA20 Fuel Line Plumbing C132026
- DC Jacket Water Heater Wiring Diagrams
- AC Wiring Diagrams
- Parts Illustration
- Language Translation Pages

All the above can be located on www.clarkefire.com as follows:

- ❖ For all documents listed above, use the following steps to get to the document pages that you are looking for:

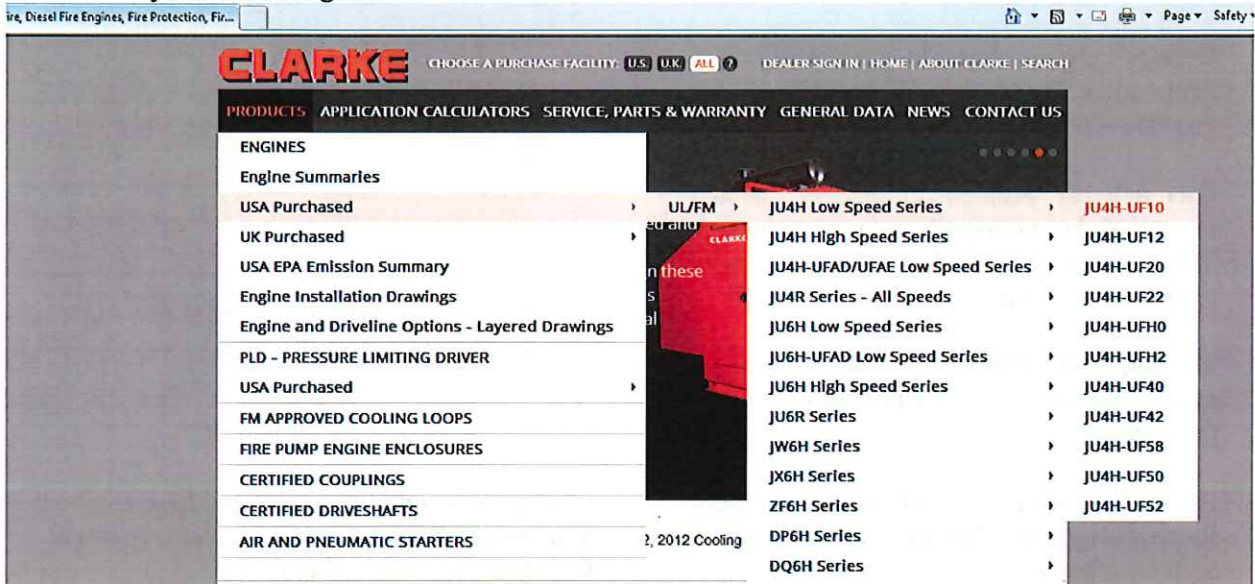

DOCUMENTS

- ▶ Specification Sheet
- ▶ Power Curve
- ▶ Installation and Operations Data
- ▶ Material/Construction
- ▶ Installation Drawing
- ▶ Emission Data
- ▶ Noise Data

FORMS

- ▶ Proposal

ADDITIONAL RESOURCES

- ▶ Operations Manual
- ▶ Wiring Diagrams
- ▶ General Data
- ▶ NFPA20 Reference Data
- ▶ Parts
- ▶ Warranty
- ▶ Language Translation Pages

JU4H-UF10

Engines >> UL/FM >> JU4H Low Speed Series

SPECIFICATIONS

Number of Cylinders	4
Aspiration	NA
Rotation*	Clockwise (CW)
Weight - lb(kg)	910 (413)
Compression Ratio	17.6:1

1.0 INTRODUCTION

The following paragraphs summarize the “Scope of Supply” of the Engine:

- The CLARKE Engine supplied has been designed for the sole purpose of driving a stationary Emergency Fire Pump. It must not be used for any other purpose.
- Shall not be subjected to Horsepower requirements greater than the certified nameplate rating (for UL/cUL/FM only).
- Engines must be sized to cover fully the maximum power absorbed by any particular driven equipment together with a safety factor on no less than 10%. (For Non-listed only).
- Derates for elevation ambient and temperature need to be considered for maximum pump power.
- Fuel delivery settings are factory set and must not be tampered with or adjusted. Minor RPM adjustments to meet pump requirements are permissible.
- The engine shall be installed and maintained in accordance with the guidelines stated in this manual.
- Periodic running checks to ensure functionality should be kept to a maximum of ½ hour per week.

1.1 IDENTIFICATION/NAMEPLATE

- Throughout this manual, the terms “Engine” and “Machine” are used.
- The term “Engine” refers solely to the diesel engine driver as supplied by CLARKE.
- The term “Machine” refers to any piece of equipment with which the engine might interface.

This manual provides all the information necessary to operate your newly acquired engine safely and efficiently, and perform routine servicing correctly. Please read it carefully.

MODEL NUMBERING & IDENTIFICATION

There are two identification plates attached to each engine. Clarke Identification Plate: Engine Model, Serial Number, Rating and Date of Manufacture are shown on this identification plate. The JU Series identification plate is mounted on the flywheel housing at the rear of the engine. The JW Series identification plate is mounted on right rear engine mount. The JX Series identification plate is mounted on the flywheel housing at the rear of the engine.

Note that there are two types of Clarke identification plates, dependent on whether the engine is a “Non-Listed” or “Listed/Approved” Model. These are typical examples. (See *Figure #1*)

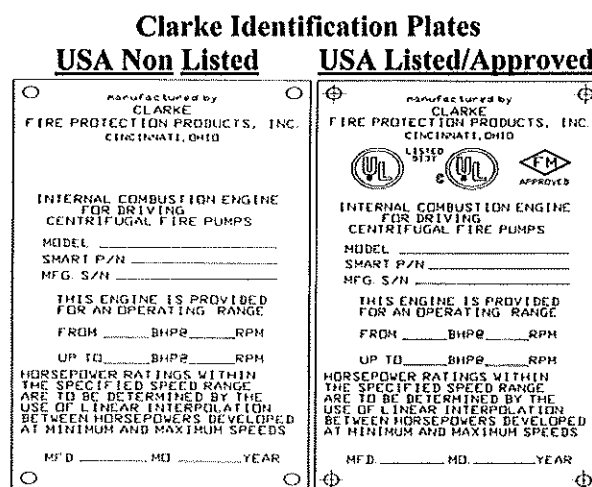

Figure #1

Clarke model number reflects the base engine type, number of cylinders, cooling system, approval listing and a power rating code.

Example: JX6H-UFAD50

- J = John Deere base engine
- X = base engine series (12.5 liter)
- 6 = number of cylinders
- H = Heat Exchanger cooled (R = Radiator)
- UF = Underwriters Laboratories Listed/Factory Mutual Approved, (NL = Non-Listed)
- A = Manufacture Location
- D = Tier 3, A = Non-Emissionized
- 50 = A power rating code

John Deere Identification Plate: The second identification plate contains the John Deere Model Number and Serial Number. On the JW Series, the John Deere Serial identification plate is located on

the left-hand side of the engine between the intake manifold and starting motor. On the JU Series, the John Deere identification plate is located on the right side of the cylinder block behind the fuel filter. On the JX Series, the John Deere Serial identification plate is located on the left-hand side of the engine between the intake manifold and starting motor.

1.2 SAFETY/CAUTION/WARNINGS

ATTENTION: This engine has components and fluids that reach very high operating temperatures and is provided with moving pulleys and belts. Approach with caution. It is the responsibility of the builder of the machine using a Clarke engine to optimize the application in terms of maximum end user safety.

BASIC RULES

The following recommendations are given to reduce the risk to persons and property when an engine is in service or out of service.

Engines must not be used for applications other than those declared under "Scope of Supply".

Incorrect handling, modifications and use of non-original parts may affect safety. When lifting the engine, take care to use suitable equipment to be applied to the points specially provided as shown on the appropriate Engine Installation Drawing. Engine weights are shown in *figure #2*

ENGINE MODEL	WEIGHT lbs (kg)
JU4H-UFAD4G	1490
JU4H-UFAD5G	1490
JU4H-UFAD58	1490
JU4H-UFADJG	1490
JU4H-UFADP0	1490
JU4H-UFADR0	1490
JU4H-UFADW8	1490
JU4H-UFADY8	1490
JU4H-UFAD98	1490
JU6H-UFADK0	1747
JU6H-UFADN0	1747
JU6H-UFAD58	1747
JU6H-UFADNG	1747
JU6H-UFADP8	1747
JU6H-UFAD88	1747
JU6H-UFADM8	1747
JU6H-UFADMG	1747

JU6H-UFADT0	1902
JU6H-UFADP0	1902
JU6H-UFADQ0	1902
JU6H-UFADR0	1902
JU6H-UFADS0	1902
JU6H-UFAD98	1902
JU6H-UFADR8	1902
JU6H-UFADS8	1902
JU6H-UFADW8	1902
JU6H-UFADX8	1902
JW6H-UFAD80	2094
JW6H-UFADB0	2094
JW6H-UFADD0	2094
JW6H-UFADF0	2094
JW6H-UFADJ0	2094
JW6H-UFAD70	2094
*JW6H-UFAA60	2094
*JW6H-UFAAM8	2094
*JW6H-UFAA80	2094
JX6H-UFADF0	3315
JX6H-UFAD60	3315
JX6H-UFADK0	3315
JX6H-UFADN0	3315
JX6H-UFADP0	3315
JX6H-UFAD88	3315

Figure #2

* Non-Emissionized

Figure #3 shows the typical lifting arrangement of a bare engine. Note the lifting points on the engine are for lifting the engine only. *Caution, when lifting, lift point should always be over the equipment Center of Gravity.*

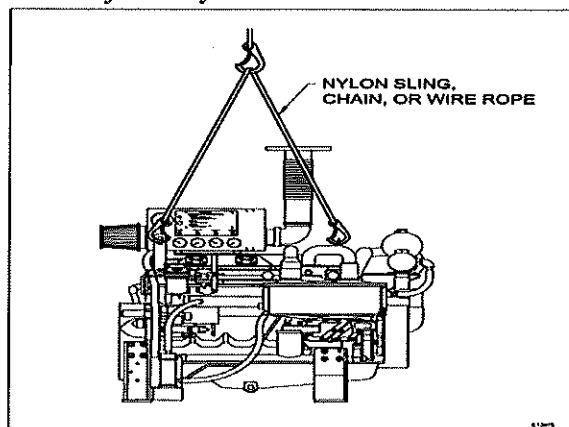

Figure #3

Figure #4 shows the typical lifting arrangement of a base mounted engine and pump set when the base (or module) is furnished with lifting holes.

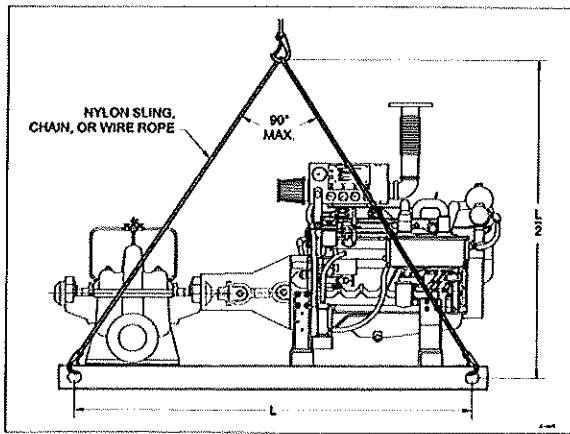

Figure #4

When Clarke furnishes the base (or module) for the engine and pump set, the combined weight of the engine and base (or module) will be indicated on the unit. *Caution, when lifting, lift point should always be over the equipment Center of Gravity.*

Note: The engine produces a noise level exceeding 70 dB(a). When performing the weekly functional test, it is recommended that hearing protection be worn by operating personnel.

CLARKE UK provides the machine manufacturer with a "Declaration of Incorporation" for the Engine, when required, a copy of which is enclosed in the manual. This document clearly states the machine manufacturers' duties and responsibilities with respect to health and safety. Refer to *Figure #5*.



Fire Protection Products, Inc.

3133 East Kemper Road • Cincinnati, Ohio • 45241 • USA

Tel: +1 (513) 771-2200 • Fax: +1 (513) 771-0726

DECLARATION OF INCORPORATION

We hereby declare that the engine is intended to be incorporated into other machinery and must not be put into service until the relevant machinery, into which the engine is to be incorporated, has been declared in conformity with the essential health and safety requirements of the machinery Directive 2006/42/EC and consequently the conditions required for the CE Mark.

We declare that the engine is manufactured in accordance with the following Standards and Directives:

**Directive 2006/42/EC, 2004/108/EC, 2006/95/ECEC
Standards EN ISO 12100:2010, EN 60204-1:2006**

1) Description – Diesel Engines

Manufacturer – Clarke Fire Protection Products, USA

Model Number –

Serial Number –

Year of Manufacture –

Contract Number –

Customer Order Number –

- 2) The engine has moving parts, areas of high temperatures and high temperature fluids under pressure. In addition it has an electrical system, which may be under strong current.
- 3) The engine produces harmful gases, noise and vibration and it is necessary to take suitable precautionary measures when moving, installing and operating the engine to reduce risk associated with the characteristics stated above.
- 4) The engine must be installed in accordance with local laws and regulations. The engine must not be started and operated before the machinery into which it is to be incorporated and/or its overall installation has been made to comply with local laws and regulations. The engine must only be used in accordance with the scope of supply and the intended applications.

Signed _____
Ken Wauligman – Engineering Manager

Date: _____

C13944_rev. E 16July12

WHAT TO DO IN AN EMERGENCY

Any user of the Engine who follows the instructions set out in this manual, and complies with the instructions on the labels affixed to the engine are working in safe conditions.

If operating mistakes cause accidents call for help
If operating mistakes cause accidents call for help immediately from the EMERGENCY SERVICES.

In the event of an emergency, and while awaiting the arrival of the EMERGENCY SERVICES, the following general advice is given for the provision of first aid.

FIRE

Put out the fire using extinguishers recommended by the manufacturer of the machine or the installation.

BURNS

- 1) Put out the flames on the clothing of the burns victim by means of:
 - × drenching with water
 - × use of powder extinguisher, making sure not to direct the jets onto the face
 - × blankets or rolling the victim on the ground
- 2) Do not pull off strips of clothing that are sticking to the skin.
- 3) In the case of scalding with liquids, remove the soaked clothing quickly but carefully.
- 4) Cover the burn with a special anti-burn packet or with a sterile bandage.

CARBON MONOXIDE POISONING (CO)

Carbon monoxide contained in engine exhaust gases is odorless and dangerous because it is poisonous and with air, it forms an explosive mixture.

Carbon monoxide is very dangerous in enclosed premises because it can reach a critical concentration in a short time.

When attending a person suffering from CO poisoning in enclosed premises, ventilate the premises immediately to reduce the gas concentration.

When accessing the premises, the person providing the aid must hold his breath, not light flames, turn on lights or activate electric bells or telephones so as to avoid explosions.

Take the victim to a ventilated area or into the open air, placing him on his side if he is unconscious.

CAUSTIC BURNS

- 1) Caustic burns to the skin are caused by acid escaping from the batteries:
 - × remove the clothes
 - × wash with running water, being careful not to affect injury-free areas
- 2) Caustic burns to the eyes are caused by battery acid, lubricating oil and diesel fuel.
 - × Wash the eye with running water for at least 20 minutes, keeping the eyelids open so that the water runs over the eyeball and moving the eye in all directions.

ELECTROCUTION

Electrocution can be caused by:

- 1) The engine's electrical system (24VDC)
- 2) The coolant pre-heating system 120/240 Volt AC (if supplied).

In the first case, the low voltage does not involve high current flows through the human body; however, if there is a short circuit, caused by a metal tool, sparks and burns may occur.

In the second case, the high voltage causes strong currents, which can be dangerous.

If this happens, break the current by operating the switch before touching the injured person.

If this is not possible, bear in mind that any other attempt is highly dangerous also for the person assisting; therefore, any attempt to help the victim must be carried out without fail using means that are insulating.

WOUNDS AND FRACTURES

The wide range of possible injuries and the specific nature of the help needed means that the medical services must be called.

If the person is bleeding, compress the wound externally until help arrives.

In the case of fracture do not move the part of the body affected by the fracture. When moving an injured person permission from that person must be received until you can help him. Unless the injury is life threatening, move the injured person with extreme care and then only if strictly necessary.

WARNING LABELS

Warning labels, in picture form, are applied to the engine. Their meanings are given below.

Important Note: Labels that show an exclamation mark indicate that there is a possibility of danger.

Heat Exchanger Maximum Working Pressure



Coolant Mixture



Lifting Point

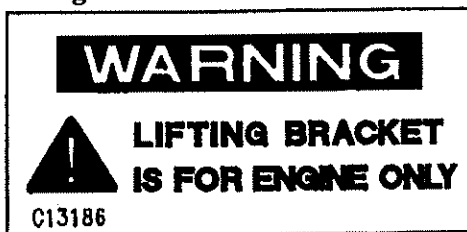

Automatic Start



Rotating Parts



Jacket Water Heater Voltage

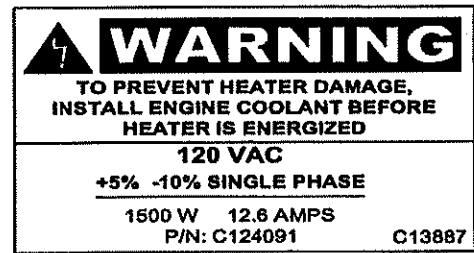

Air Filter Installation

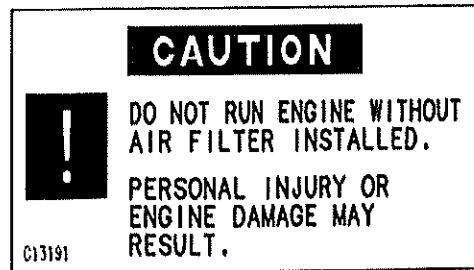

1.3 PRECAUTIONS FOR WELDING

IMPORTANT: ALWAYS disconnect electronic Control Module (ECM) connectors before welding. High currents or electrostatic discharge in electronic components from welding may cause permanent damage. Connect the welder ground close to the welding point and be sure ECM or other electronic components are not in ground path.



Welding Precautions

2.0 INSTALLATION/OPERATION

2.1 TYPICAL INSTALLATION

A typical Fire Pump installation is shown in *Figure #6*.

1. Pump/Engine set
2. Main Pump Controller
3. Pump discharge
4. Air louver
5. Entrance door with air louver
6. Exhaust silencer
7. Exhaust system supports

8. Exhaust outlet pipe
9. Concrete base
10. Exhaust flexible connection joint/pipe

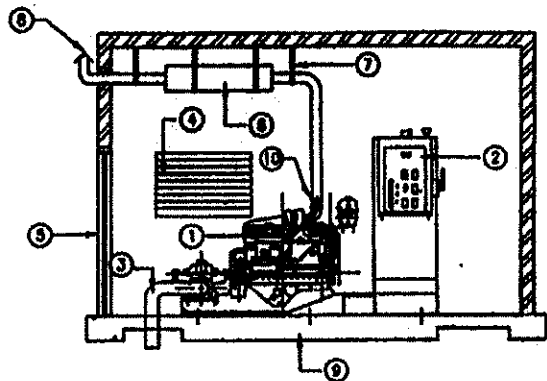

Figure #6
Typical Installation

2.2 ENGINE STORAGE

2.2.1 Storage less than 1 year

Storing engines requires special attention. Clarke engines, as prepared for shipment, may be stored for a minimum of one year. During this period, they should be stored indoors in a dry environment. Protective coverings are recommended provided they are arranged to allow for air circulation. The stored engine should be inspected periodically for obvious conditions such as standing water, part theft, excess dirt buildup or any other condition that may be detrimental to the engine or components. Any such conditions found must be corrected immediately.

2.2.2 Extended Storage Maintenance Procedure

After a one year storage period or if the engine is being taken out of service for more than 6 months, additional preservation service must be performed as follows:

- 1) Drain the engine oil and change the oil filter.
- 2) Refill the engine crankcase with MIL-L-21260 preservative oil.
- 3) Change the fuel filter.
- 4) Install the coolant plugs and install coolant in the normal mix percentage of 50% coolant, 50% water, premixed.
- 5) Remove the protection from the intake and exhaust openings.
- 6) Prepare a container as a fuel source using a mixture of Mobilarma or Sta-Bil with **ONLY** Diesel #2 fuel or "Red" diesel fuel (ASTM D-975) or BS2869 Class A2. (Refer to section 3.1.1 for Fuel Specification.)

- 7) Disconnect the coupling or drive shaft from the pump.
- 8) Start and run the engine at a slow speed for 1-2 minutes being careful not to exceed the normal operating temperature.
- 9) Drain the oil and coolant.
- 10) Replace the protective plugs that were used for shipping and storage.
- 11) Attach to the engine a visible card, specifying "ENGINE WITHOUT OIL" DO NOT OPERATE".

IMPORTANT: THIS TREATMENT MUST BE REPEATED EVERY 6 MONTHS

PUTTING ENGINE INTO SERVICE AFTER ADDITIONAL PRESERVATION SERVICE:

To restore the normal operation running conditions of the engine, carry out the following:

- 1) Fill the engine sump with the normal recommended oil, to the required level.
- 2) Remove the protective plugs used for shipping and storage.
- 3) Refill cooling water to proper level.
- 4) Remove the card "ENGINE WITHOUT OIL, DO NOT OPERATE".
- 5) Follow all steps of the Installation Instructions when the engine will be put into service.

2.3 INSTALLATION INSTRUCTIONS

The correct installation of the engine is very important to achieving optimum performance and extended engine life.

In this respect, the engine has certain installation requirements, which are critical to how it performs. These requirements are generally associated with the cooling, exhaust, induction air, and fuel systems.

This section of the manual should be read in conjunction with the relevant Installation and Operation Data Sheets. If there is any doubt about an installation, contact should be made with Clarke Customer Support giving exact details of the problem.

All installations should be clean, free of any debris and dry. Care should be taken to ensure that there is easy access to the engine for maintenance and repair. The safety of personnel who may be in the area of the engine when it is running is of paramount importance when designing the installation layout.

- 1) Secure pump set to foundation and complete installation in accordance with pump manufacturer's instructions. Perform engine-to-pump coupling alignment. Lubricate Falk coupling with supplied grease or driveshaft universal joints with NLGI grade #1 or #2 grease at the (3) Zerk fittings. (Refer to section 2.4 for specific alignment instructions).
- 2) Install the heat exchanger discharge pipe. The discharge pipe should be no smaller than the outlet connection on the heat exchanger. Discharge water piping should be installed in accordance with applicable codes. All plumbing connecting to the heat exchanger must be secured to minimize movement by the engine. Cooling loop water pressure to the heat exchanger must not exceed the limit that is stated on the heat exchanger supplied with the engine.
- 3) Install all engine cooling system draincocks and plugs. Close all drain cocks at (DAVE TO IDENTIFY).....

Qty	Description	Location	Engine Model
1	1/8" draincock	Water Heater inlet tube	JU4H / JU6H
1	1/8" draincock	Coolant heater inlet tube	JW6H
1	Plug RE46686	Oil Cooler	JU4H / JU6H
1	3/8" pipe plug	Heat exchanger	JW6H
1	Electrode plug	Bottom of heat exchanger	JU4H / JU6H
1	1/8" draincock	Water Heater inlet	JX6H
1	Electrode plug	Bottom of heat exchanger	JX6H
1	1/4" draincock	Water Pump Inlet Hose	JX6H

- 4) Fill engine cooling system with premixed 50% water / 50% coolant solution. Use only coolants meeting ASTM-D6210 specifications for heavy-duty diesel engines. Never use light-duty or automotive coolants in the engine that are stated as ASTM-D3306 only. (Refer to *Figure #18* of Instruction Manual in Section 3.4.3 for cooling system capacity.) Fill expansion tank per figure #19A, Section 3.4.5 of Instruction Manual.
- 5) Engine is shipped with oil **installed**. For make-up oil specifications refer to section 3.3 Lubrication System.
- 6) Connect fuel supply and return line to fuel supply tank plumbing. Reference the Fuel

System section of the Installation and Operation Data in (see Page 5), for piping size, maximum allowable fuel pump suction, and maximum allowable fuel head requirements. Fill supply tank with #2 diesel fuel (ASTM D-975) or BS 2869 Class A2 "Red" diesel fuel, bleed supply system of air and check for leaks.

CAUTION: Biodiesel fuel is not recommended for stand-by equipment that can have minimal fuel consumption (such as standby generators, fire protection, etc.). For standby applications, use only petroleum based diesel fuel with John Deere approved fuel conditioners/additives. For fuel conditioners/additives, check with your local John Deere dealer or Clarke. Fuel supply level must meet applicable code requirements. Do not use a copper based or galvanized material for any component of a diesel fuel system. The fuel will chemically react with the zinc resulting in clogged fuel filters and injector systems.

- 7) Remove protective covering on air filter element.
- 8) Connect jacket water heater (if supplied) to AC power source. For JU6 Series the electrical supply requirements are indicated on the heater body. Connect the supplied heater connection wire directly to a customer supplied electrical junction box. For JW6/JX6 Series the electrical supply requirements are indicated on the connection box. Connect to the heater directly to the junction box at the end of the heater only. ***Supply wiring should never be routed through the engine gauge panel.*** Severe damage to critical engine control components could result. Energize heater only after step #4 is completed.
- 9) Connect exhaust system to flexible connection on the engine. The exhaust system plumbing must be supported by the building structure and not the engine. The exhaust flexible connection is provided only for the purpose of thermal expansion and vibration isolation, not for misalignment or directional change.
- 10) Make electrical DC connections between the engine gauge panel terminal strip (if supplied) and the controller per the controller manufacturer's instructions.
- 11) Fill batteries with electrolyte per battery manufacturer's instructions. Connect cables between engine and batteries only after electrolyte is installed. Refer to the wiring

diagram inside the engine gauge panel cover (if supplied), or appropriate wiring diagram (see Page 5), for correct positive and negative connections. Connect negative cables directly to the engine block. Connect each positive cable to the large outer post of the manual starting contactors.

- 12) Note: Clarke Operation and Maintenance Instructions Manual, C132679, are located inside the engine gauge panel.
- 13) Note: During commissioning of the engine, the final speed setting must be performed on both the Primary and Alternate ECM's. Refer to section 3.6 Speed Adjustment.
- 14) IMPORTANT! In order to obtain prompt Warranty Service and to comply with Emissions Regulations, this engine **must** be registered to the final installation name and address. To register this engine, go to www.clarkefire.com and select Warranty Registration.

2.4 SPECIFIC FLYWHEEL COUPLING ALIGNMENT INSTRUCTIONS

2.4.1 Driveshaft

To check the alignment of the pump shaft and engine crankshaft centerlines for proper Parallel Offset and Angular tolerance, the drive shaft must be installed between the flywheel and the flanged hub on the pump shaft.

Before beginning the alignment checks and making any necessary corrections, install the driveshaft and re-torque all driveshaft connection bolts to the values given in the following table:

MODELS	DRIVE SHAFT	BOLT SIZE /MATERIAL GRADE	TIGHTENING TORQUE ft-lbs (N-m)
JU4H-UFAD4G	CDS20-SC	1/2-20 Grade 8 (Hi-Tensile)	75 - 82 (102 - 112)
JU4H-UFAD5G JU4H-UFAD58 JU4H-UFADJG JU4H-UFADP0 JU4H-UFADR0 JU4H-UFADW8 JU4H-UFADY8	CDS30-S1	3/8-24 Grade 8 (Hi-Tensile)	30 - 35 (41 - 48) (see note #2)

JU4H-UFAD98 JU6H-UFADP8 JU6H-UFADP0 JU6H-UFADT0 JU6H-UFADS0 JU6H-UFAD88 JU6H-UFAD98 JU6H-UFADR8 JU6H-UFADS8 JU6H-UFADS0 JU6H-UFADW8 JU6H-UFADX8 JU6H-UFADM8 JU6H-UFADMG JW6H-UFAD80 JW6H-UFADB0 JW6H-UFADD0 JW6H-UFADP0 JW6H-UFADJ0 JW6H-UFAD70	CDS50-SC	7/16-20 Grade 8 (Hi-Tensile)	50 - 55 (68 - 75) (see note #2)
JX6H-UFADF0 JX6H-UFAD60 JX6H-UFADK0 JX6H-UFADN0 JX6H-UFADP0 JX6H-UFAD88	SC2160A	M16, Class 10.9 (Metric) (Hi-Tensile)	100 - 105 (135 - 142) (see note #2)

Note 1 – It is recommended that a medium strength threadlocker (Loctite 243-blue) be used in the assembly and torquing of all hardware. This may be purchased as part number C126758, 50ml bottle.

Note 2 – 4 of the hi-tensile bolts and/or nuts, that are used to connect the driveshaft to the drive disc and that connect the driveshaft to the pump companion flange, will require a “crow’s foot” wrench attached to a standard torque wrench in order to apply the required tightening torque. A standard socket will not work due to close proximity of the bolts and/or nuts with the driveshaft yoke. The tightening torque values listed for these bolts and/or nuts have been corrected for using a “crow’s foot” adapter which extends the standard torque wrench’s length.

Before removing the drive shaft guard, disconnect the negative battery cable from both batteries.

The following steps describe the proper way to check alignment. A small pocket scale or ruler with millimeter markings is recommended to make all measurements.

- A) To check the Horizontal Parallel Offset, the driveshaft must be in the proper orientation.
 1. Rotate the shaft so the reference “AB” on the flywheel adapter disc or the circumference of the drive shaft flange (against the flywheel adapter disc) is in the 12 o’clock position shown on *figure #7a*.
 2. Measure from the face of the flywheel adapter disc to point E. (Point E is on the

bearing bore as shown in *Figure #7a*). This measurement must be:

Measurement	Driveshaft
58 ± 1mm.	CDS10-SC / SC41 / SC41A
68 ± 1.5mm.	CDS20-SC / SC55 / SC55A
68 ± 1.5mm.	CDS20-S1 / SC55L-A
92 ± 1.5mm.	CDS30-S1 / SC61L-A
109 ± 2mm.	CDS50-SC / SC81A
123.5 ± 1.5mm	SC2160A

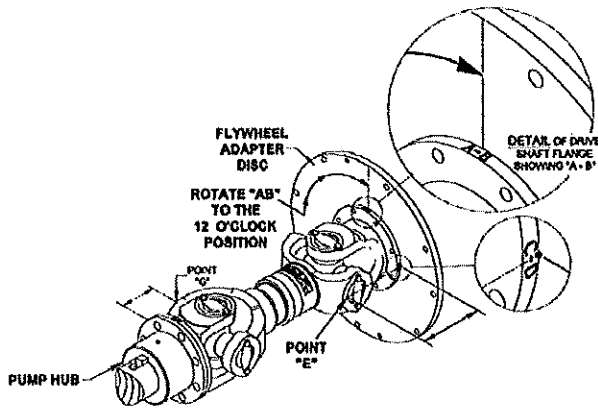

Figure #7a

B) With the driveshaft in the same orientation as the previous step (Step A), check the Horizontal Angular alignment of the shafts.

1. Measure from the mating surface of the companion hub to point G shown on figure #7b. (Point G is the furthestmost point on the bearing bore). This measurement must be equal to the measurement at point E ± 0.5 mm.

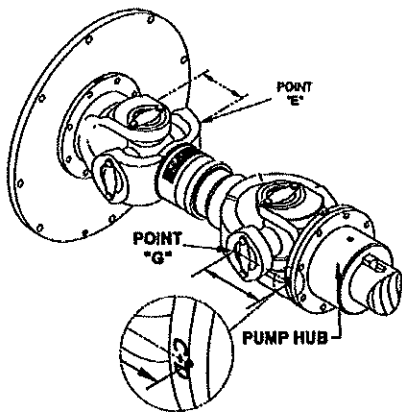

Figure #7b

C) To check the Vertical Parallel Offset, the driveshaft must be re-orientated.

1. Rotate the shaft 90° so the reference "CD" on the flywheel adapter disc or the circumference of the drive shaft flange (against the flywheel) is in the position shown on *Figure#7c*.
2. Measure from the face of the flywheel adapter disc to point H. (Point H is the

furthestmost point on the bearing bore diameter). The measurement must be:

Measurement	Driveshaft
60 ± 1mm.	CDS10-SC / SC41 / SC41A
70.5 ± 1mm.	CDS20-SC / SC55 / SC55A
70.5 ± 1mm.	CDS20-S1 / SC55L-A
94.5 ± 1mm.	CDS30-S1 / SC61L-A
112.5 ± 1mm.	CDS50-SC / SC81A
126.5 ± 1mm	SC2160A

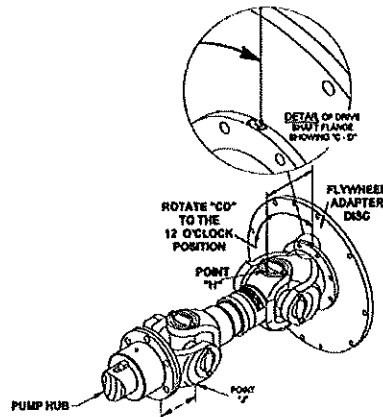
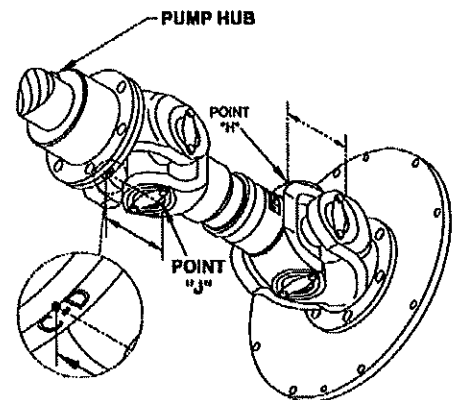

Figure #7c

D) With the driveshaft in the same orientation as the previous step (Step C), check the Vertical alignment of the shafts.

1. Measure from the mating surface of the pump companion hub of the drive shaft to point J as shown in figure #7d. (Point J is the same as point G, with the driveshaft rotated 90°). This measurement must be equal to the measurement at point H ± 1 mm.

Re-install all guards and grease fittings before reconnecting the battery cables.



Figure#7d

DRIVESHAFT MAINTENANCE

1. To service the driveshaft disconnect the negative battery cables, remove the top of guard and set aside.

2. Rotate engine shaft manually so the u-joint grease fittings are accessible.
3. Using a hand held grease gun with N.L.G.I. grade 1 or 2 grease position on grease fitting. Pump with grease until grease is visible at all four cap seals.
4. Verify all driveshaft connecting bolts remain tight. Re-torque per 2.4.1 if necessary.
5. Reinstall top of guard and connect negative battery cables.

2.4.2 Falk “Steelflex” Coupling

JX engines are offered with an optional FALK “Steelflex” drive hub.

If your engine includes this type of coupling, please refer to Appendix “A” for installation, alignment and maintenance information. To achieve final installation alignment Limits (see Table 2 of appendix), shims are provided with the engine. Shim as required under the engine feet to achieve proper alignment

TYPE T10 STEELFLEX COUPLING

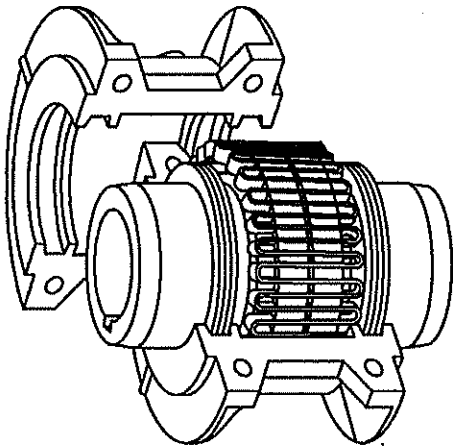

2.5 WEEKLY TEST

An experienced operator should be present during the weekly test.

NOTE: This engine is designed to operate at rated load conditions. For testing purposes the engine can be run at lower load (lower flow) conditions. Running times in any one period should not exceed 30 minutes maximum.

Before starting the engine make sure of the following:

- 1) The operator has free access to stop the engine in an emergency.

- 2) The plant room ventilation ducts are open and the engine has good access for air.
- 3) All the guards are in position and, if not, for whatever reason, any rotating parts will be free and clear without restriction.
- 4) Battery covers are in place and there is nothing on top of or touching the engine, which is not part of the original supply specification.
- 5) The raw water supply for cooling is available without restriction. Typically restriction occurs from a plugged cooling loop strainer.

When engine is running make sure that the coolant temperature, oil pressure and raw cooling water flow are within the limits specified on the relevant Installation & Operation Data Sheet (see Page 5).

If the coolant temperature is excessive, check:

- a) Cooling loop strainers
- b) Proper functioning of thermostat
- c) Condition of heat exchanger tube bundle

2.6 STARTING/STOPPING THE ENGINE

2.6.1 To Start Engine

Use main pump controller for starting. Follow instructions provided by controller manufacturer.

On UL/FM engines, use main pump controller for starting and stopping the engine. Should the main pump controller become inoperable, the engine can be manually started and stopped from the engine gauge panel. For manual starting and stopping of an engine with a gauge panel: Position **MODE SELECTOR** to **MANUAL RUN**. (Refer to *Figure #9*). Lift and hold **MANUAL CRANK #1**, until engine starts, or release after 15 seconds. If unit fails to start, wait for 15 seconds, use **MANUAL CRANK #2** and repeat step. If **RAW COOLING WATER** is not flowing or engine **COOLANT TEMPERATURE** is too **HIGH**, open cooling system manual by-pass valves.

Note: On JW/JX Engines you can also start engines using manual starting contactors.

IMPORTANT: Main pump controller selector should be in the OFF position when starting from engine gauge panel. Be sure to return selector on main pump controller and engine gauge panel to **AUTOMATIC** after completing manual run.

2.6.2 To Stop Engine

If engine is started from main pump controller use main pump controller to stop the engine.

If engine is started from engine gauge panel: Lift and hold **MANUAL STOP SWITCH**, until engine stops. Close cooling system manual by-pass valve if opened.

Note: Lift and hold this switch to prevent engine from starting during the cycle-crank testing.

IMPORTANT: DO NOT leave the **MODE SELECTOR** switch in the **MANUAL RUN** position during **AUTOMATIC** operation. (The controller will be unable to stop the engine and **DAMAGE MAY RESULT**).

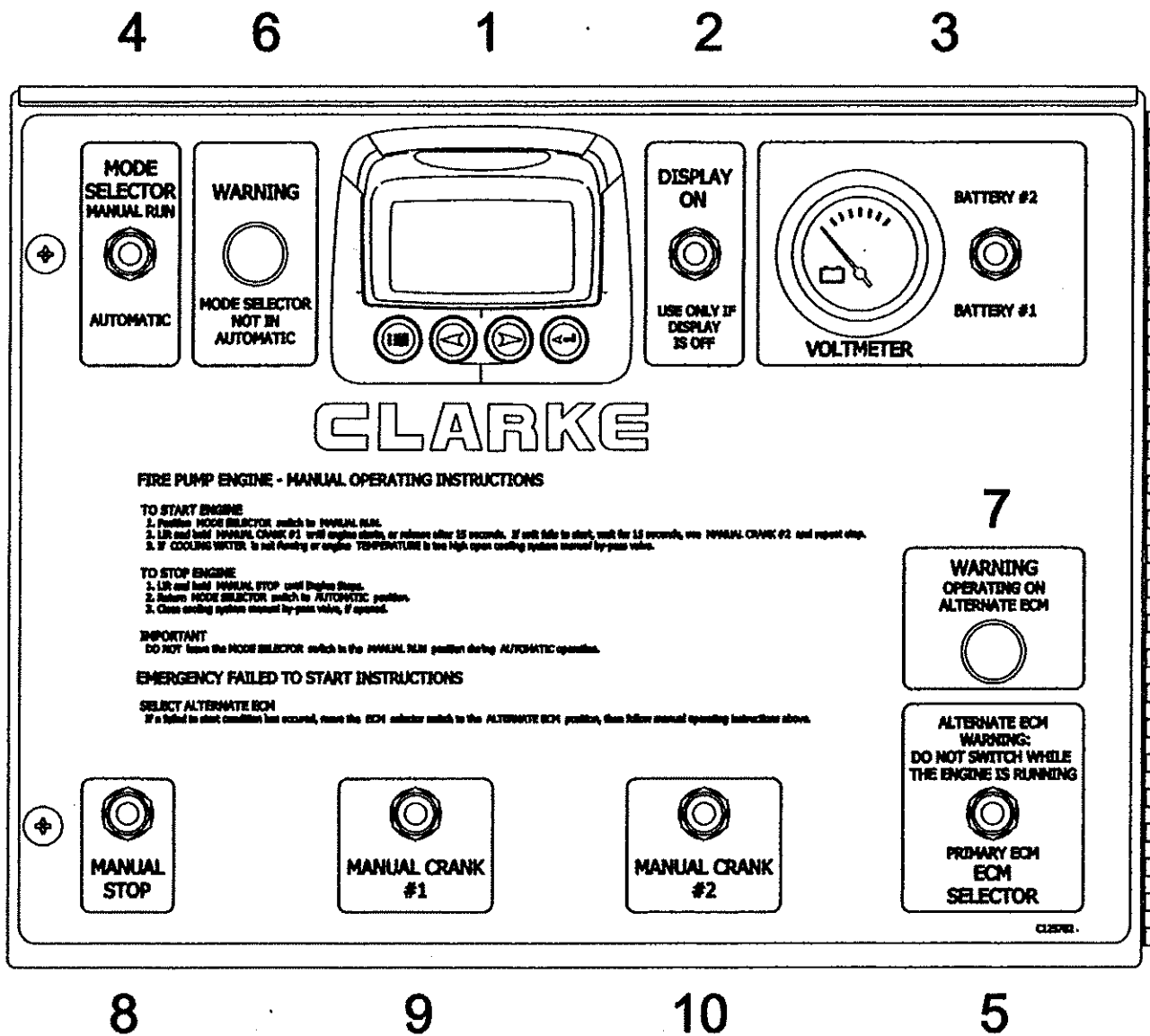

Figure #9

- 1 - PowerView Gauge
- 2 - Momentary Display On Switch
- 3 - Voltmeter/Battery Selector Switch
- 4 - Automatic/Manual Mode Selector Switch
- 5 - ECM Selector Switch

- 6 - Manual Mode Indicator Warning Light
- 7 - Alternate ECM Indicator Warning Light
- 8 - Manual Stop Switch
- 9 - Manual Crank Switch - Battery #1
- 10 - Manual Crank Switch - Battery #2

2.6.3 Describing Engine Gauge Panel

2.6.3.1 ECM Selector Switch and Primary/Alternate ECM

Clarke UL/FM Engines come equipped with dual ECMs and an ECM Selector Switch on engine gauge panel. (Item #6). Default position of ECM selector switch is to the Primary ECM. In the event of a failure of the Primary ECM, where-by the engine shuts down or will not start, it will become necessary to manually switch to the Alternate ECM position. When the ECM Selector Switch is positioned to the Alternate ECM position a warning light will illuminate at the engine gauge panel. Also, the main controller will display a warning light and an audible alarm. The engine should then be re-started manually. (See section 2.6.1). Contact a Clarke Authorized Service Dealer immediately when this situation occurs to troubleshoot. (See section 7.0).

Information displayed on the PowerView diagnostic gauge will come from either the Primary or Alternate ECM depending upon the position of the ECM Selector Switch.

If a fault code(s) is displayed and comes from the Primary ECM, and then the ECM selector switch is moved to the Alternate ECM position, it may be necessary to “crank” the engine in order for the Alternate ECM to pick-up the same fault code(s).

2.6.3.2 Dual ECM Automatic Switching

Engine models utilizing dual ECMs are equipped with a BASE unit (Board for Auto-Switching ECMs) that can detect failure on either primary or alternate ECM. The BASE monitors two separate heartbeat signals from each of the ECMs. If the BASE fails to detect BOTH of these signals, the BASE will recognize this as an ECM failure and initiate the automatic ECM switching process. If the BASE fails to detected only one of these signals, the automatic ECM switching process will not initiate however an indication will be made by a green status LED on the BASE.

- Normal Operation: LED Flashes at 1/10 Hz or 1 time in 10 seconds
- Primary heartbeat failure only: Led Flashes at ½ Hz or 5 times in 10 seconds.

- Secondary heartbeat failure only: LED Flashes at 1 ½ Hz or 15 times in 10 seconds.

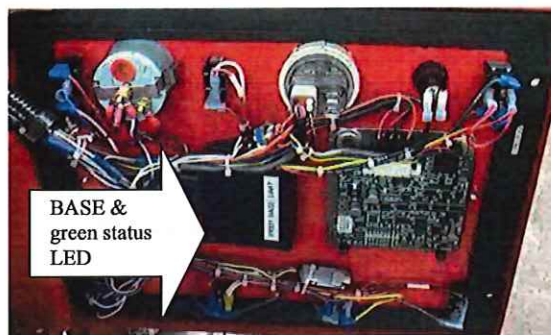

Interior view of instrument control panel door - BASE dual ECM auto-switching device and green LED

If the currently selected ECM experiences a failure detected by the BASE unit, an ECM warning alarm will be sent to the fire pump controller via interconnect terminal 303, and will automatically switch to the other functional ECM. If the automatic switching devices switches to alternate ECM, a visual indication light will illuminate on the engine control panel, and an alternate ECM alarm will be sent to the fire pump controller via interconnect terminal 301. Upon failure of the second ECM, the automatic switching device will alarm an ECM failure alarm to the fire pump controller via interconnect terminal 304. Additionally, the BASE status LED will flash at rate of 2 ½ Hz or 25 times in 10 seconds.

If an ECM failure occurs during engine operation, the automatic switching device will control engine shutdown and will prevent starter motor re-engagement while the engine is shutting down. After the engine safely comes to a stop the automatic switching device will switch to the other functional ECM and will then allow starter motor re-engagement control from the fire pump controller.

The automatic ECM switching process will not initiate upon failure of any primary, alternate, or non-critical engine sensors as per UL/FM.

After ECM repair, activate the ECM Failure reset switch to the down position for 3 seconds and release. This will de-activate the ECM Warning and Failure alarms to the fire pump controller at interconnect terminals 303 and 304.

The hand operated ECM selector switch allows for manual selection of either primary or alternate ECM.

In the event of failure of the BASE unit while the ECMs are functional, a Diagnostic Trouble Code of SPN 2145 FMI 9 will be displayed on the diagnostic gauge.

2.6.3.3 Using the PowerView Gauge

The PowerView gauge (reference Figure #9A) allows the operator to view operating conditions and diagnostic trouble codes (DTC's).

Press the menu key (B) to access the various engine functions in sequence. The displays can be selected as either customary English or metric units.

The following menu of engine parameters can be displayed on the power view (refer to *Figure #9A*).

1. Engine rpm*
2. Coolant temperature*
3. Oil pressure*
4. Machine hours*
5. System voltage (rectified voltage of battery #1 & #2)
6. Percent engine load at the current rpm
7. Throttle position
8. Intake manifold temperature
9. Current fuel consumption
10. Active service (diagnostic) codes
11. Store service (diagnostic) codes from the engine
12. Set the units for display
13. View the engine configuration parameters

* These four parameters are fixed for the power-up display.

The PowerView gauge includes a liquid crystal display (LCD) screen. The display can show either a single parameter or a quadrant display showing four parameters simultaneously. The diagnostic gauge uses two arrow keys (C) for scrolling through the engine parameter list and viewing the menu list and an enter key (D) for selecting highlighted items. The red (E) and amber (F) lights are used to signal active trouble codes received by the diagnostic gauge.

NOTE:

- Red indicator light (E) indicates a serious condition. Correct problem before restarting.
- Amber indicator light (F) indicates an abnormal condition. It is not necessary to shutdown engine immediately but problem should be corrected as soon as possible.

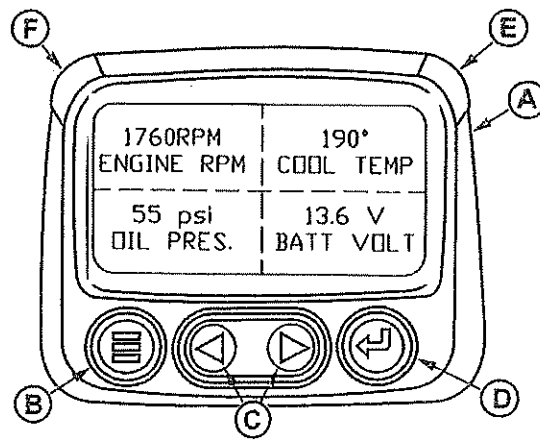

Diagnostic Gauge

- A—Diagnostic Gauge
- B—Menu Key
- C—Arrow Keys
- D—Enter Key
- E—Red "STOP ENGINE" Indicator Light
- F—Amber "WARNING" Indicator Light

Figure #9A

Setup the 1-Up Display



Note: Not recommended for Clarke Engines. 1-Up display should be used for diagnostic needs only.

Main Menu Navigation

NOTE: The engine does not need to be running to navigate the diagnostic gauge screens. It will display information when the batteries are connected. If engine start up is desired see: Starting The Engine. All of the engine values illustrated in this example on the diagnostic gauge indicate the engine is running.

1. Starting at the four engine parameter display, press the "Menu" key.

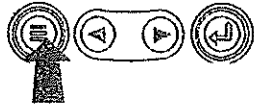
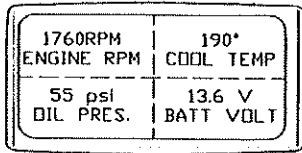

- The first seven items of the "Main Menu" will be displayed.

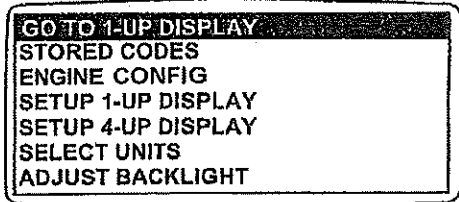

Menu Display

- Pressing the "Arrow" keys will scroll through the menu selections.

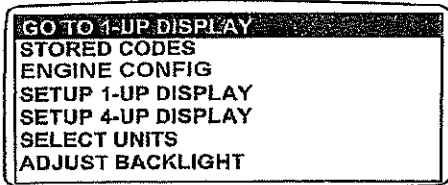

Main Menu Items

- Pressing the right arrow key will scroll down to reveal the last items of "Main Menu" screen, highlighting the next item down.

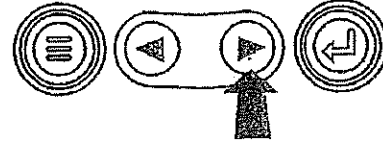
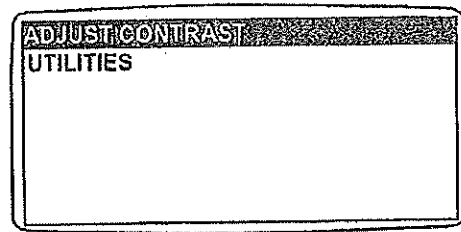

Last Items On Main Menu

- Use the arrow keys to scroll to the desired menu item or press the "Menu Button" to exit the main menu and return to the engine parameter display.

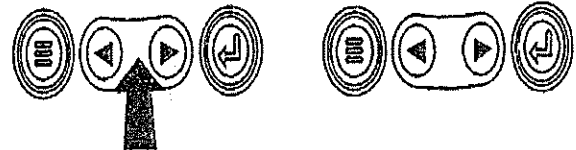
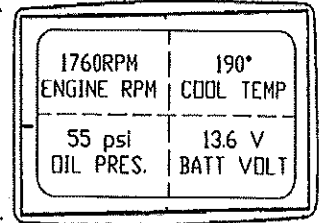
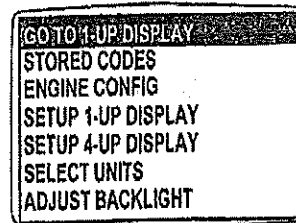

Use Arrow Buttons To Scroll / Quadrant Display

Engine Configuration Data

NOTE: The engine configuration data is a read only function. All engine configuration parameters are pre-set by Clarke.

- Starting at the four engine parameter display, press the "Menu" key.

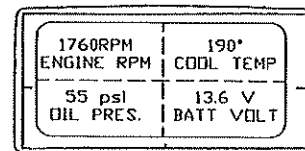

- The main menu will be displayed. Use the "Arrow" keys to scroll through the menu until "Engine Config" is highlighted.

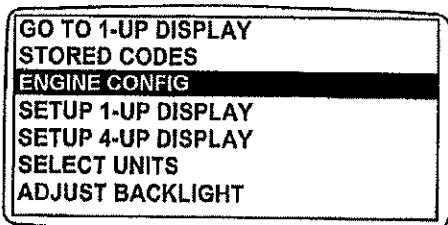

Select Engine Configuration

- Once "Engine Config" menu item has been highlighted, press the "Enter" key to view the engine configuration.

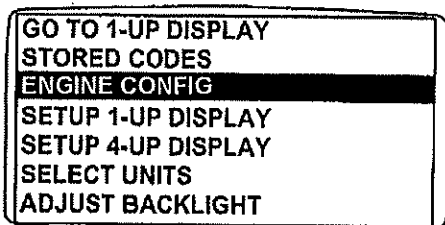

Enter Key

- Use the "Arrow" keys to scroll through the engine configuration data.

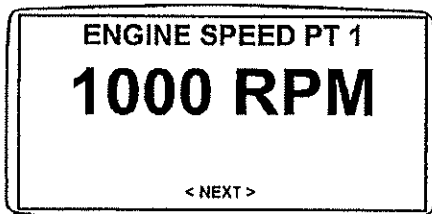

Use Arrow Keys To Scroll

- Press the "Menu" key to return to the main menu.

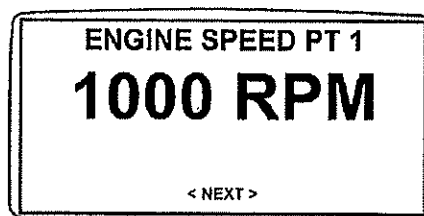

Return To Main Menu

- Press the "Menu" key to exit the main menu and return to the engine parameter display.

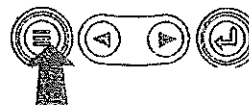
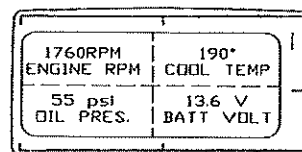

Accessing Stored Trouble Codes

- Starting at the four engine parameter display, press the "Menu" key.

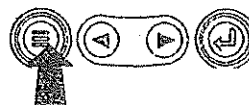
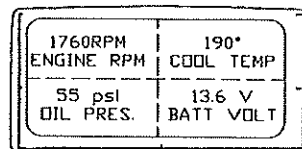

- The main menu will be displayed. Use the "Arrow" keys to scroll through the menu until "Stored Codes" is highlighted.

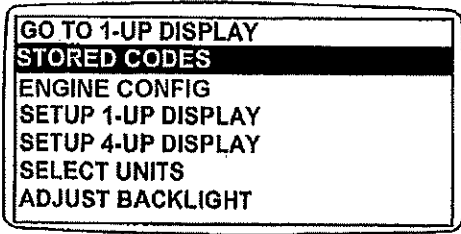

Select Stored Codes

- Once the "Stored Codes" menu item has been highlighted press the "Enter" key to view the stored codes.

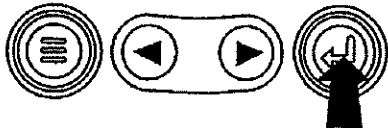
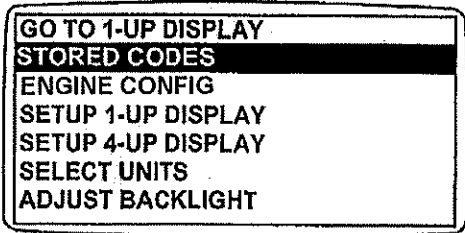

Enter Key

- If the word "Next" appears above the "Arrow" keys, there are more stored codes that may be viewed. Use the "Arrow" key to scroll to the next stored code.

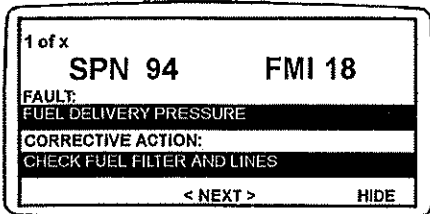

Use Arrow Keys To Scroll

- Press the "Menu" key to return to the main menu.

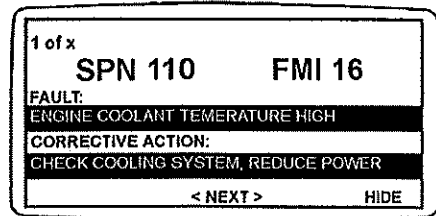

Return To Main Menu

- Press the "Menu" key to exit the main menu and return to the engine parameter display.

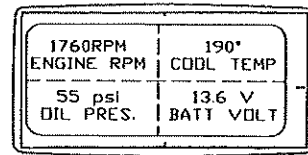

Accessing Active Trouble Codes

For description of trouble codes, see chart in Troubleshooting Section.

- During normal operation the four parameter screen will be displayed.

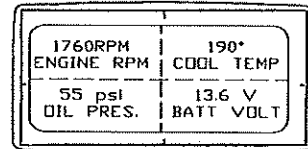

- When the diagnostic gauge receives a trouble code from an engine control unit. The single or four parameter screen will be replaced with the "Warning" message. The SPN and FMI number will be displayed along with a description of the problem and the corrective action needed.

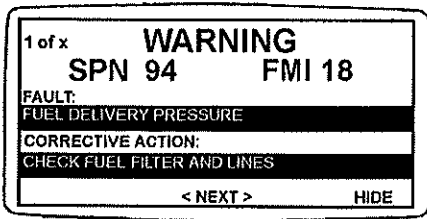

Active Trouble Codes Displayed

IMPORTANT: Ignoring active trouble codes can result in severe engine damage.

3. If the word "Next" appears above the arrow keys, there are more trouble codes that can be viewed by using the arrow keys to scroll to the next trouble code.

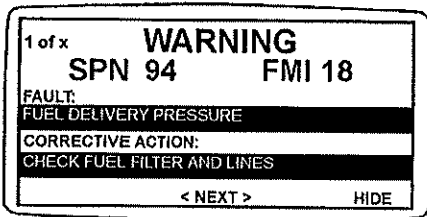

Use Arrow Keys To Scroll

4. To acknowledge and hide the code and return to the single of four parameter display, press the "Enter" Key.

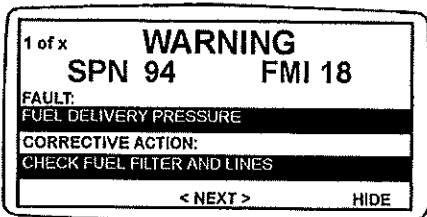

Hide Trouble Codes

5. The display will return to the single of four parameter display, but the display will contain the warning icon. Pressing the "Enter" key will redisplay the hidden trouble code.

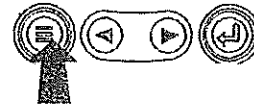
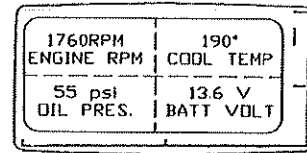

6. Pressing the "Enter" key once again will hide the trouble code and return the screen to the single or four parameter display.

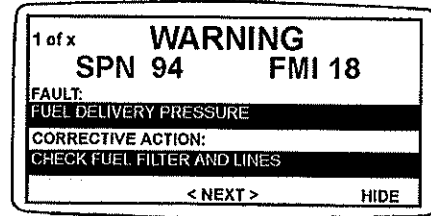

Enter Key

7. The single or four parameter screen will display the warning icon until the trouble code condition is corrected.

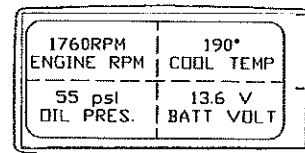

Engine Shutdown Codes

Note: For Clarke Engine models the only shutdown will be due to an overspeed condition.

1. During the normal operation the four parameter screen will be displayed.

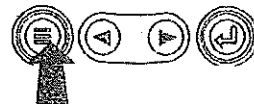
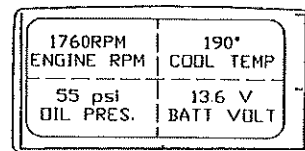

- When the diagnostic gauge receives a severe trouble code from an ECM, the four parameter screen will be replaced with the "Shutdown" message. The SPN and FMI number will be displayed along with a description of the problem and the corrective action needed.

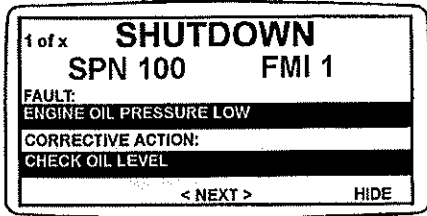

Shutdown Message

If the word "Next" appears above the arrow key, there are more trouble codes that can be viewed by using the arrow keys to scroll to the next trouble code.

- To acknowledge and hide the trouble code and return to the four parameter display, press the "Enter" key.

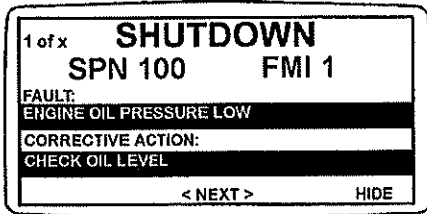

Hide Trouble Code

- The display will return to the four parameter display, but the display will contain the "Shutdown" icon. Pressing the "Enter" key will redisplay the hidden code.

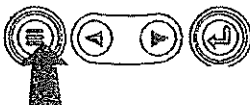
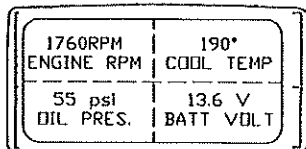

- Pressing the "Enter" key once again will hide the trouble code and return the screen to the four parameter display.

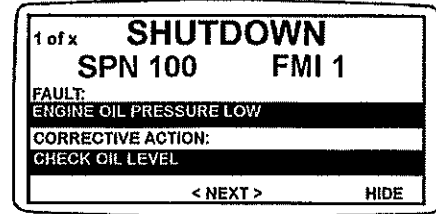

Redisplay Trouble Code

- The four parameter screen will display the shutdown icon until the trouble code condition is corrected.

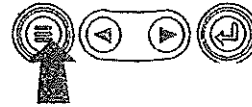
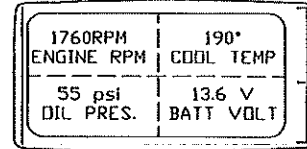

Adjusting Backlighting

- Starting at the four engine parameter display, press the "Menu" key.

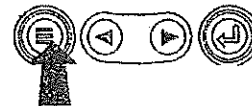
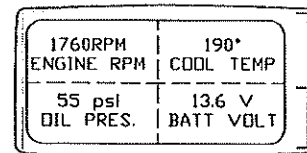

- The main menu will be displayed. Use the "Arrow" keys to scroll through the menu until "Adjust Backlight" is highlighted.

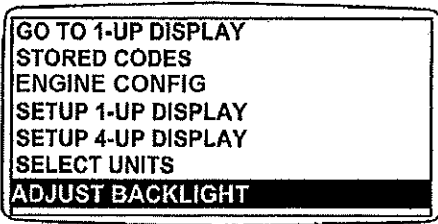

Select Adjust Backlight

- Once the "Adjust Backlight" menu item has been highlighted, press the "Enter" key to activate the "Adjust Backlight" function.

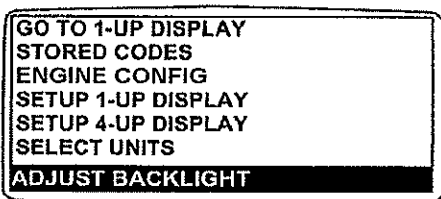

Press Enter Key

- Use the "Arrow" keys to select the desired backlight intensity.

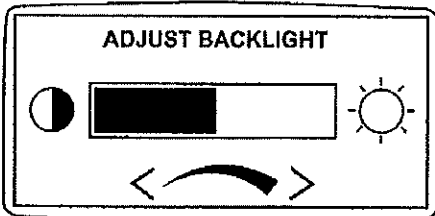

Adjust Backlight Intensity

- Press the "Menu" key to return to the main menu.

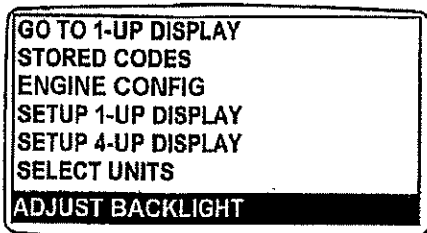

Return To Main Menu

- Press the "Menu" key to exit the main menu and return to the engine parameter display.

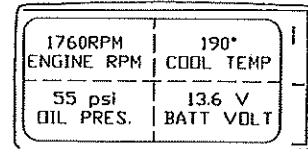

Adjusting Contrast

- Starting at the single or four engine parameter display press the "Menu" Key.

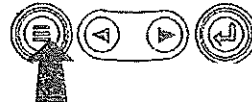
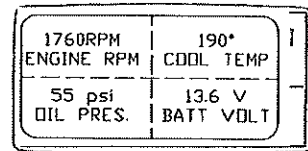

- The main menu will be displayed. Use the "Arrow" keys to scroll through the menu until "Adjust Contrast" is highlighted.

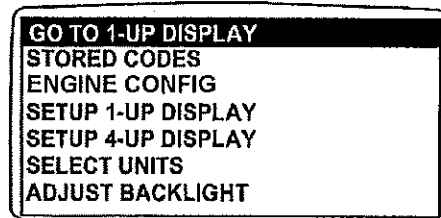

Select Adjust Contrast

- Once the "Adjust Contrast" menu item has been highlighted, press the "Enter" key to activate the "Adjust Contrast" function.

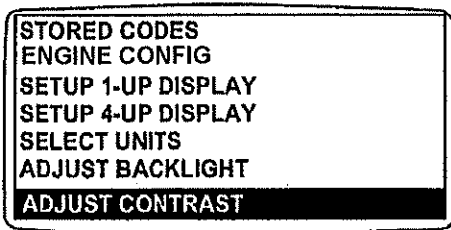

Press Enter Key

- Use the "Arrow" keys to select the desired contrast intensity.

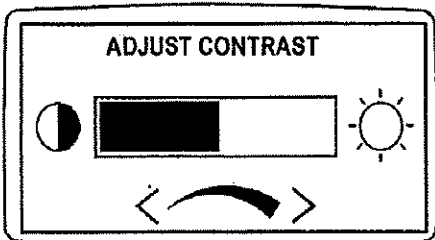

Adjust Contrast Intensity

- Press the "Menu" key to return to the main menu.

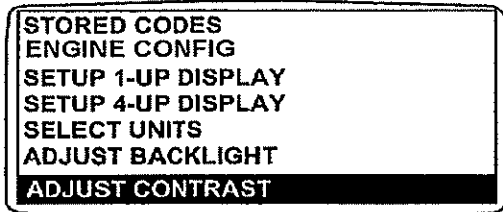

Return To Main Menu

- Press the "Menu" key to exit the main menu and return to the engine parameter display.

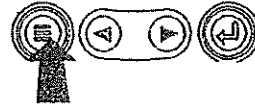
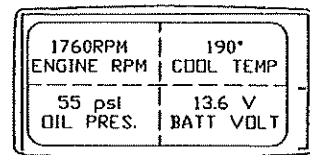

Selecting Units of Measurement

- Starting at the four engine parameter display press the "Menu" Key.

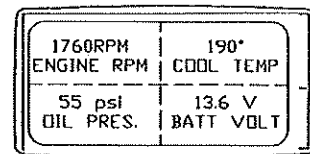

- The main menu will be displayed. Use the "Arrow" keys to scroll through the menu until "Select Units" is highlighted.

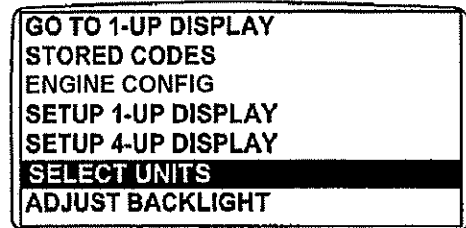

Select Units

- Once the "Select Units" menu item has been highlighted, press the "Enter" key to activate the "Select Units" function.

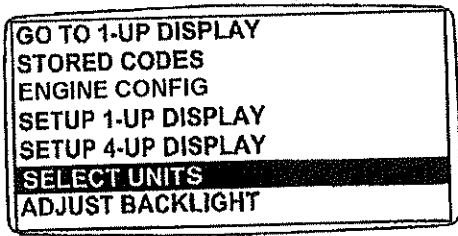

Press Enter Key

- There are three choices for units of measurements, English, Metric kPa or Metric Bar.

English is for Imperial units, with pressures displayed in PSI and temperatures in °F.

Metric kPa and Metric bar are the IS units, with pressures displayed in kPa and bar respectively, and temperatures in °C.

Use the “Arrow” keys to highlight the desired units of measurements.

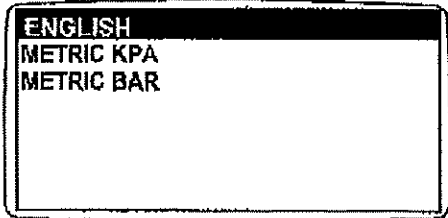

Select Desired Units

- Press the “Enter” key to select the highlighted units.

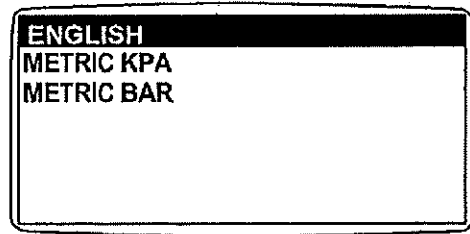

Press Enter Key to Select

- Press the “Menu” key to return to the main menu.

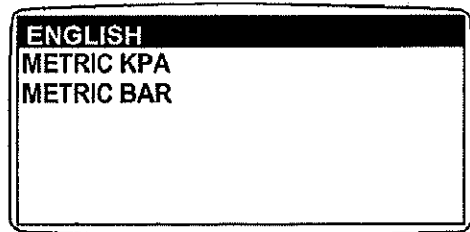

Press Enter Key to Select

- Press the “Menu” key to return to the engine parameter display.

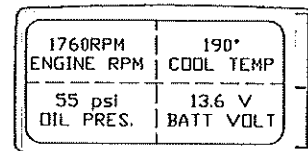

Displaying Diagnostic Gauge Software

NOTE: The following steps can be used to display the software version of the diagnostic gauge if needed by your dealer for troubleshooting. This is a read only function.

- Starting at the four engine parameter display, press the “Menu” key.

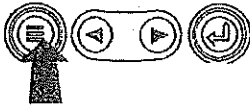
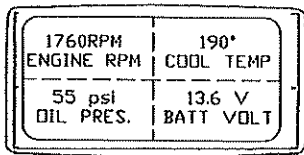

- The main menu will be displayed. Use the "Arrow" key to scroll through the menu until "Utilities" is highlighted.

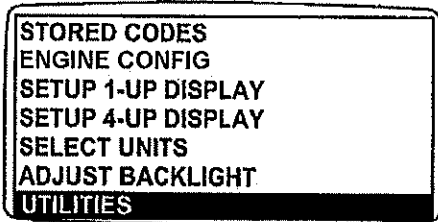

Select Utilities

- Once "Utilities" is highlighted, press "Enter" to activate the utilities function.

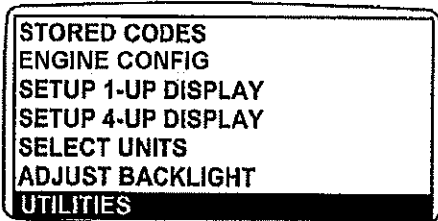

Select Utilities

- Scroll to the "Software Version". Press "Enter" to view the software version. Press the menu button twice to return to the main menu.



Software Version

3.0 ENGINE SYSTEMS

3.1 FUEL SYSTEM

3.1.1 Diesel Fuel Specification

All diesel fire pump drivers manufactured by Clarke are designed, tested and warranted for use only with No. 2-D Diesel Fuel conforming to ASTM International D-975-11b or British Standard BS2869:2010+A1:2011 Fuels oils for agricultural, domestic and industrial engines and boilers - Specification.

Although the above referenced fuel specifications allow limited amounts of Biodiesel, 100% petroleum fuel is preferred and should be used whenever possible. Biodiesel in any amount greater than that allowed by the above referenced specifications should not be used. The use of fuels not referenced above, or Biodiesel in amounts greater than allowed in the above referenced specifications, may affect performance and reliability, and may result in a non-warrantable engine condition.

To insure engine reliability and performance, the fuel provided for Clarke fire pump drivers must be maintained in a quality condition. Refer to NFPA 25 2014, reprint provided below, for guidance to the minimum requirements for fuel maintenance for all Clarke fire pump engine installations.

The following is reprinted from the "NFPA 25 2014 Standard for the Inspection, Testing, and maintenance of Water-Based Fire Protection Systems," Copyright © 2013 National Fire Protection Association®. All Rights Reserved.

8.3.4 Diesel Fuel Testing and Maintenance

8.3.4.1 Diesel fuel shall be tested for degradation no less than annually.

8.3.4.1.1* Fuel degradation testing shall comply with ASTM D975-11b Standard Specification for Diesel Fuel Oils, or ASTM D6751 -11b Standard Specification for Biodiesel Fuel Blend Stock (B100) for Middle Distillate Fuels as approved by the engine manufacturer, using ASTM D 7462 - 11 Standard Test Method for Oxidation Stability of Biodiesel (B100) and Blends of Biodiesel with Middle Distillate Petroleum Fuel (Accelerated Method).

8.3.4.2* If diesel fuel is found to be deficient in the testing required in 8.3.4.1.1, the fuel shall be reconditioned or replaced, the supply tank shall be cleaned internally, and the engine fuel filter(s) shall be changed.

8.3.4.2.1 After the restoration of the fuel and tank in 8.3.4.2, the fuel shall be retested each 6 months until experience indicates the fuel can be stored for a minimum of one year without degradation beyond that allowed in 8.3.4.1.1

8.3.4.3 When provided, active fuel maintenance systems shall be listed for fire pump service.

8.3.4.3.1 Maintenance of active fuel maintenance systems shall be in accordance with the manufacturer's recommendations.

8.3.4.3.2 Maintenance of active fuel maintenance systems shall be performed at a minimum annual frequency for any portion of the system that the manufacturer does not provide a recommended maintenance frequency.

8.3.4.3.3 Fuel additives shall be used and maintained in accordance with the active fuel maintenance system manufacturer's recommendations.

A.8.3.4.1.1 Commercial distillate fuel oils used in modern diesel engines are subject to various detrimental effects from storage. The origin of the crude oil, refinement processing

techniques, time of year, and geographical consumption location all influence the determination of fuel blend formulas. Naturally occurring gums, waxes, soluble metallic soaps, water, dirt, blends and temperature all contribute to the degradation of the fuel as it is handled and stored. These effects begin at the time of fuel refinement and continue until consumption. Proper maintenance of stored distillate fuel is critical for engine operation, efficiency, and longevity.

Storage tanks should be kept water-free. Water contributes to steel tank corrosion and the development of microbiological growth where fuel and water interface. This and the metals of the system provide elements that react with fuel to form certain gels or organic acids, resulting in clogging of filters and system corrosion. Scheduled fuel maintenance helps to reduce fuel degradation. Fuel maintenance filtration can remove contaminants and water and maintain fuel conditions to provide reliability and efficiency for standby fire pump engines. Fuel maintenance and testing should begin the day of installation and first fill.

A.8.3.4.2 Where environmental or fuel quality conditions result in degradation of the fuel while stored in the supply tank, from items such as water, micro-organisms and particulates, or destabilization, active fuel maintenance systems permanently installed on the fuel storage tanks have proven to be successful at maintaining fuel quality. An active fuel maintenance system will maintain the fuel quality in the tank, therefore preventing the fuel from going through possible cycles of degradation, risking engine reliability, and then requiring reconditioning.

3.1.2 Bleeding the Fuel System

CAUTION: Escaping fluid under pressure can penetrate the skin causing serious injury. Relieve pressure before disconnecting fuel or other lines. Tighten all connections before applying pressure. Keep hands and body away from pinholes and nozzles, which eject fluids under high pressure. Use a piece of cardboard or paper to search for leaks. Do not use your hand.

If ANY fluid is injected into the skin, it must be surgically removed within a few hours by a doctor familiar with this type of injury or gangrene may result. Doctors unfamiliar with this type of injury may call the Deere & Company Medical Department in Moline, Illinois, or other knowledgeable medical source. *Ref figure #10*



Figure #10

IMPORTANT: Fuel filter must be replaced according to maintenance schedule (See Section 4.0) or when trouble code indicates plugged filter (fuel supply pressure moderately/extremely low).

3.1.2.1 JU4/6 Engine Series:

- 1) Loosen the air bleed vent screw (A) two full turns by hand on fuel filter base. *Ref. Figure #11*
- 2) Operate supply pump primer lever (B) until fuel flow is free from air bubbles. *Ref. Figure #12.*
- 3) Tighten bleed plug securely; continue operating hand primer until pump action is not felt. Push hand primer inward (toward engine) as far as it will go.
- 4) Start engine and check for leaks.

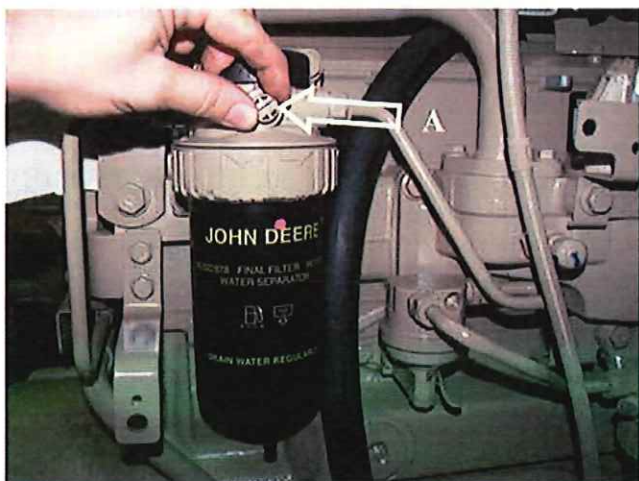

Figure #11

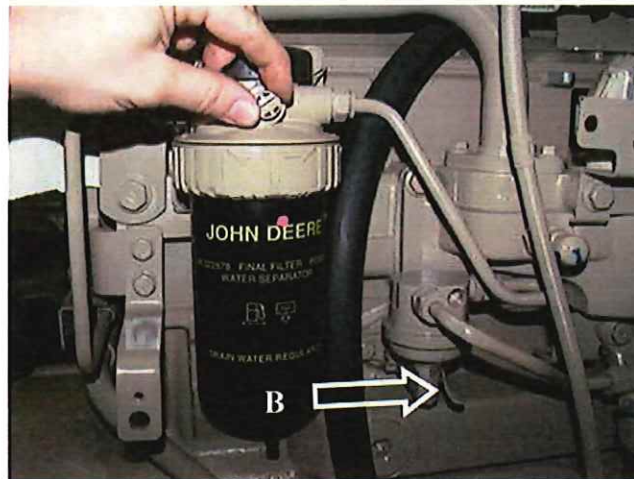

Figure #12

If engine will not start, it may be necessary to bleed air from fuel system at fuel injection pump or injection nozzles as explained next.

At High Common Pressure Rail:

- 1) Slightly loosen injector fuel line above shuttle valve (A) in high common pressure rail. *Ref figure #13*
- 2) Operate fuel supply pump primer lever until fuel, without air bubbles, flows from fuel return line connection.
- 3) Tighten return line connector at 30N-m (22 lb-ft).
- 4) Leave hand primer in the inward position toward cylinder block. *Ref. Figure #14.*

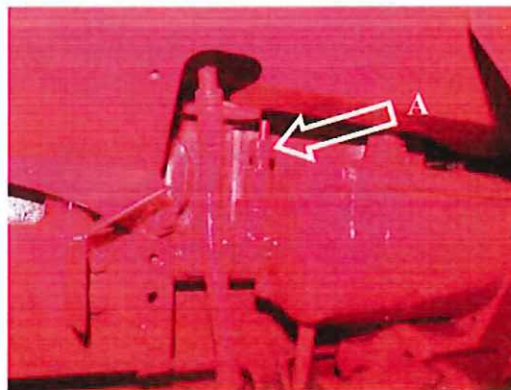

Figure #13

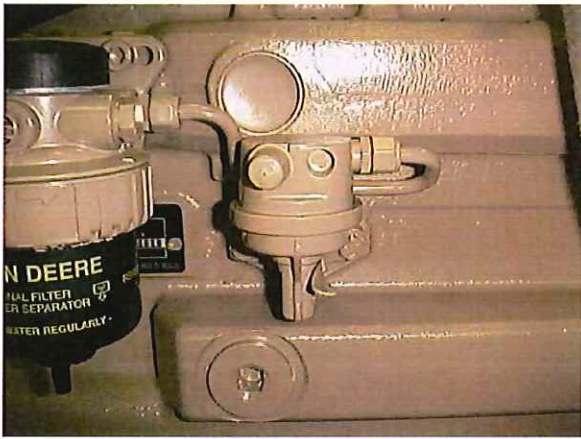

Figure #14

3.1.2.2 JW6 Engine Series:

Note: Under normal conditions, fuel system bleeding is not required. The JW6 engines have an electric fuel pump. To prime or bleed the fuel system, the electric pump will automatically turn on to maintain a correct downstream pressure

3.1.2.3 JX6 Engine Series

Note: Under normal conditions, fuel system bleeding is not required. Priming system with hand primer (B) is normally sufficient. If necessary to bleed the system, use the following procedure (Refer to *Figure 10A*).

- 1) Drain water and contaminants from water separator sediment by opening drain valve (C) and operating primer (B) until fuel is clear of water.
- 2) Attach an open line to diagnostic port (A) and place end of line in suitable container for diesel fuel.
- 3) Pump hand primer (B) until a steady flow of fuel (without bubbles) comes out of line.
- 4) Disconnect line from diagnostic port.
- 5) Start engine and run for five minutes.

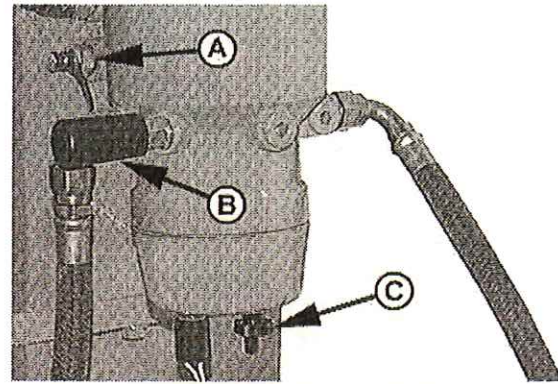

Bleeding Fuel System

- A—Diagnostic Port
- B—Hand Primer
- C—Water Drain Valve

Figure #10A

Whenever the fuel system has been opened up for service (lines disconnected or filters removed), it will be necessary to bleed air from the system.

3.1.3 Changing the Fuel Filter Cartridges

Changing the cartridges and bleed any air from the fuel system as per instructions given in section 3.1.1. Fuel filter changes should take place as per recommendations and only using approved filters. It may also be necessary to change filters out with the recommendations in the event of:

- 1) The engine has had an overhaul.
- 2) The quality of the fuel is questionable.
- 3) The engine has been subjected to temporary adverse conditions outwith its normal operating parameters.
- 4) The fuel tank condensation trap has not been drained in line with manufacturer's recommendations.

3.1.3.1 JU4/6 Engine Series

Each engine has two fuel filters, a primary filter (B) and a secondary filter (F). For the purpose of identity, the primary filter incorporates the transparent water separator.

- 1) Close fuel shut-off valve, if equipped
- 2) Thoroughly clean fuel filter assembly and surrounding area.
- 3) Disconnect water-in-fuel sensor
- 4) Loosen drain plug (C) from both filters and drain fuel into a suitable container. Ref *figure#21*

Note: Lifting up on retaining ring and rotate it helps to get past raised locators.

- 5) Firmly grasp the retaining rings (A) and rotate it counterclockwise $\frac{1}{4}$ turn. Remove ring with filter element (B). Ref *figure#21*
- 6) Inspect filter mounting bases for cleanliness. Clean as required.

Note: Raised locators on fuel filter canister must be indexed properly with slots in mounting base for correct installation.

- 7) Install new filter elements onto mounting base. Be sure element is properly indexed and firmly seated on base. It may be necessary to rotate filter for correct alignment.

If equipped with water separator, remove filter element from water separator bowl. Drain and clean separator bowl. Dry with compressed air. Install water separator bowl onto new element. Tighten securely.

- 8) Align keys on filter element with slots in filter base.
- 9) Install retaining ring onto mounting base making certain dust seal is in place on filter base. Hand tighten ring (about $\frac{1}{3}$ turn) until it “snaps” into the detent. DO NOT over tighten retaining ring.

Note: The proper installation is indicated when a “click” is heard and a release of the retaining ring is felt.

A plug is provided with the new element for plugging the used element.

- 10) Open fuel shut-off valve and bleed the fuel system. Tighten bleed plug (D). Reference *Figure #2*.

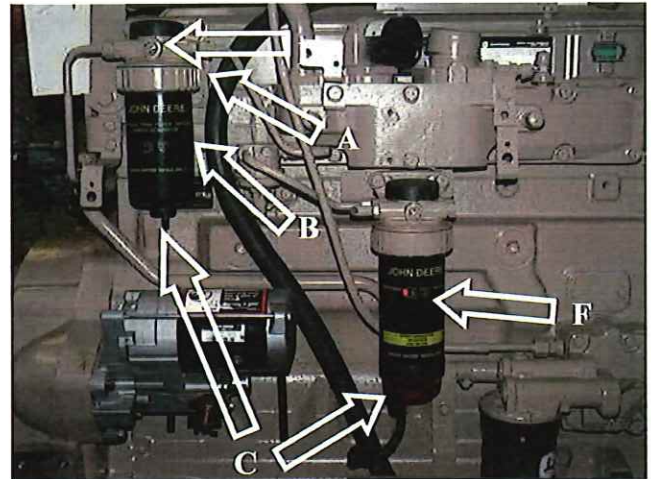

Figure #21 – JU6 models only

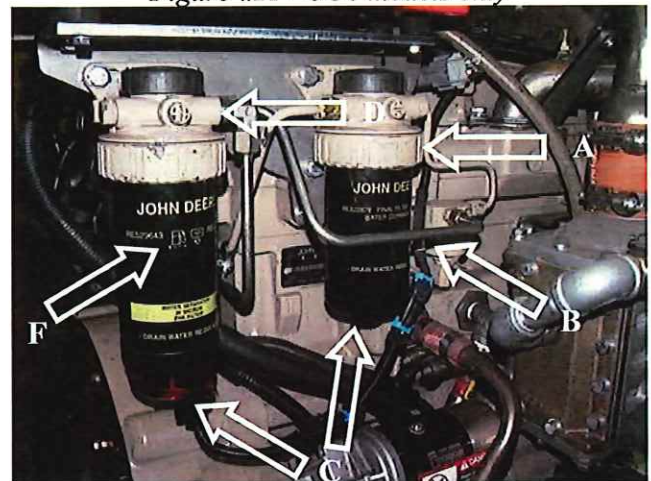

Figure #21 – JU4 models only

3.1.3.2 JW6 Engine Series

Each engine has two fuel filters. For the purpose of identity, the primary filter incorporates the transparent water separator. Both primary and secondary filters must be replaced at the same time.

Replacing Primary Fuel Filter/Water Separator

- 1) Close fuel shut-off valve at bottom of fuel tank, if equipped.
- 2) Thoroughly clean filter header (A) and surrounding area to keep from getting dirt and debris into fuel system. Ref to *figure#22*.
- 3) Loosen drain plug (B) and drain fuel into a suitable container. Ref to *figure#22*.
- 4) Disconnect water-in-fuel sensor
- 5) Turn filter canister (D) counter-clockwise (CCW) to remove.
- 6) Once filter canister is removed, pull filter element (E) down to remove from filter header (A).

- 7) Inspect filter header and filter canister sealing surfaces. Clean as required.
- 8) Place new packing on filter canister.
- 9) Place thin film of fuel on filter packing.
- 10) Place filter in canister with tangs on bottom going into canister.
- 11) Install fuel filter onto fuel filter header. Tighten until fuel filter snugly mates with fuel filter header.
- 12) Turn filter additional $\frac{3}{4}$ turn after seal contact with header.
- 13) Connect water-in-fuel sensor connector.

Replacing Secondary Fuel Filter Element

- 1) Close fuel shut-off valve at bottom of fuel tank, if equipped.
- 2) Loosen drain plug (B) and drain fuel into a suitable container. Ref *figure#22*
- 3) . Turn filter (K) counter-clockwise (CCW) to remove.
- 4) Inspect filter header surface. Clean as required.
- 5) Install new filter drain valve and tighten to 30-35 lb-in (3.4-4 Nm)
- 6) Place new filter packing (L) on filter
- 7) Place thin film of fuel on packing.
- 8) Install fuel filter onto fuel filter header. Tighten until fuel filter snugly mates with fuel filter header (I).
- 9) Turn filter additional $\frac{3}{4}$ turn after seal contact with header.

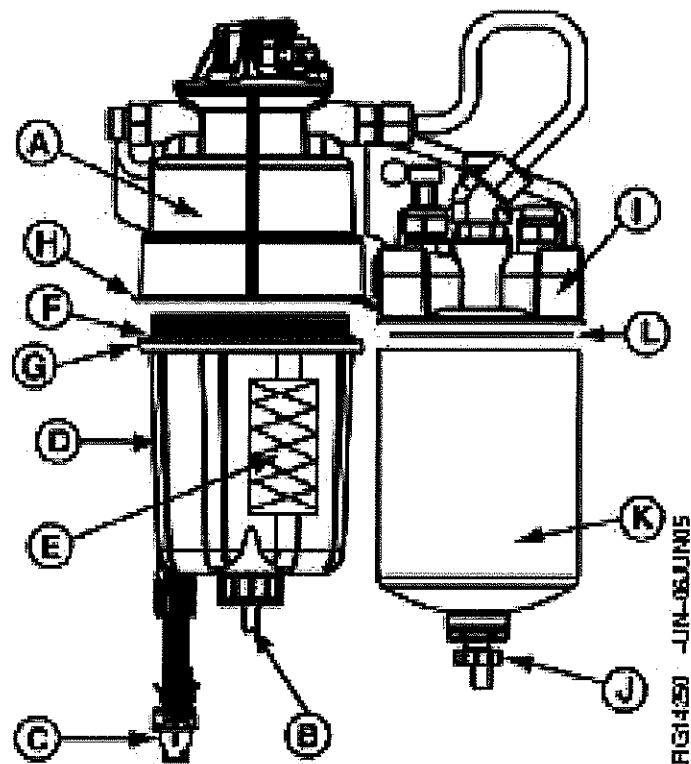

Primary and Secondary Filter Parts Kit

- A—Primary Filter Header
- B—Primary Filter Canister Drain Valve
- C—Water In Fuel Sensor Connector
- D—Primary Filter Canister
- E—Primary Filter Element
- F—Primary Filter Packing
- G—Primary Filter Canister Lip
- H—Primary Filter Header Lip
- I—Secondary Fuel Filter Header
- J—Secondary Filter Drain Valve
- K—Secondary Fuel Filter
- L—Secondary Filter Packing

Figure #22 – JW6 models only

3.1.3.3 JX6 Engine Series

Replacing Fuel Filter and cleaning the Water Separator Bowl

CAUTION: Escaping fluid under pressure can penetrate the skin causing serious injury. Relieve pressure before disconnecting fuel or other lines. Tighten all connections before applying pressure. Keep hands and body away from pinholes and nozzles which eject fluids under high pressure. Use a piece of cardboard or paper to search for leaks. Do not use your hand.

If any fluid is injected into the skin, it must be surgically removed within a few hours by a doctor familiar with this type injury or gangrene may result. Doctors unfamiliar with this type of injury may call the Deere & Company Medical Department in Moline, Illinois, or other knowledgeable medical source.

IMPORTANT: Fuel filter must be replaced according to maintenance schedule (See Section 4.0) or when trouble code indicates plugged filter (fuel supply pressure moderately/extremely low).

CAUTION: If engine has been running, engine and fuel filter housing may be hot.

- 1) Close fuel shut-off valve (if equipped).
- 2) Clean entire area surrounding fuel filter assembly to keep debris from entering fuel system.
- 3) Remove cap from fuel filter housing.
- 4) Relieve vacuum in filter housing by operating hand primer until fuel filter “pops-up”.
- 5) Lift filter element up in housing until seal clears inlet tube inside housing. Continue to hold filter suspended straight up in top of housing to drain fuel from filter.
- 6) Allow fuel to drain completely from filter into housing. Carefully begin rotating filter from housing as shown until completely upside down to ensure minimum leakage from fuel filter. (Refer to *Figure #10D*)
- 7) Place filter in container suitable for diesel fuel.

IMPORTANT: Reusing fuel filter once removed from housing may result in trapped air in the filter. This may cause fuel to overflow from the filter housing during insertion of filter element, and/or cause the engine to stall and not restart without additional system purging.

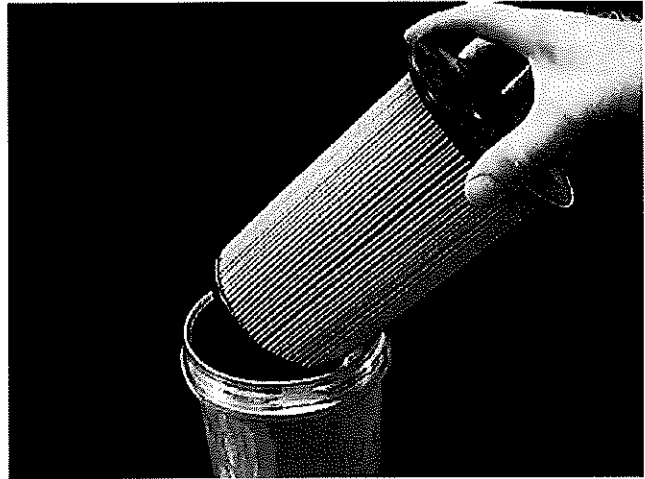
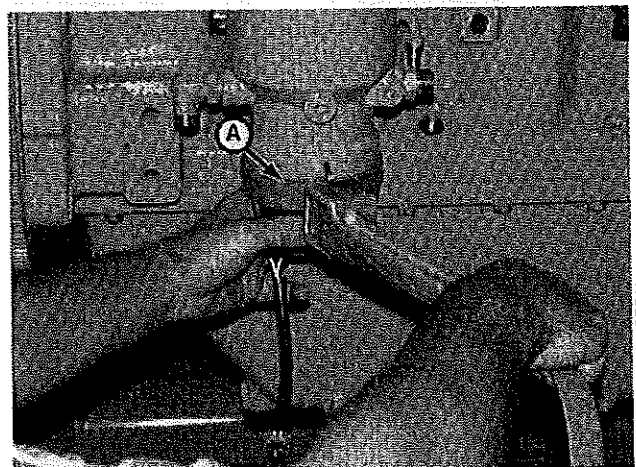

Figure #10D

Removing and cleaning the Water Separator Bowl

- 1) Disconnect wiring connector from water-in-fuel sensor.
- 2) Drain fuel from separator bowl.
- 3) Position a strap wrench (A) as close as possible to top edge of separator bowl. While applying pressure with strap wrench, grip bowl and twist with other hand as shown to remove bowl. (See *Figure #10E*)
- 4) Clean separator bowl and dry it.
- 5) Install separator bowl and tighten by hand until seal makes contact. Hand tighten to the following specification:
Water Separator Bowl-To-Filter Housing ---Torque.....5 N·m (44 lb-in)
- 6) Connect wiring to water-in-fuel sensor.



Removing Water Separator Bowl

A—Strap Wrench

Figure #10E

Install New Fuel Filter Element

- 1) Check to ensure that the fuel level in the filter housing is between the MIN (B) and MAX (A) fuel levels indicated on the outside of the housing and on the corresponding marks on the center tube. If the fuel is below the MIN level, then carefully open the fuel supply shut-off valve a small amount (if equipped) to add fuel. (Refer to *Figure #10F*) Operate the hand primer to add more fuel if required or if the unit is not equipped with a fuel supply shut-off valve.

IMPORTANT: Fuel level below the MIN indication may result in trapped air in the filter causing the engine to stall and not restart without additional system purging. Fuel level above the MAX indication may cause fuel to overflow from the filter housing during insertion of filter element.

- 2) Insert new (dry) fuel filter element into filter housing.
- 3) Reinstall fuel filter cap and tighten to "hand tight" condition.
- 4) Open the fuel supply shut-off valve (if equipped).
- 5) Restart engine and allow to run for five minutes minimum.

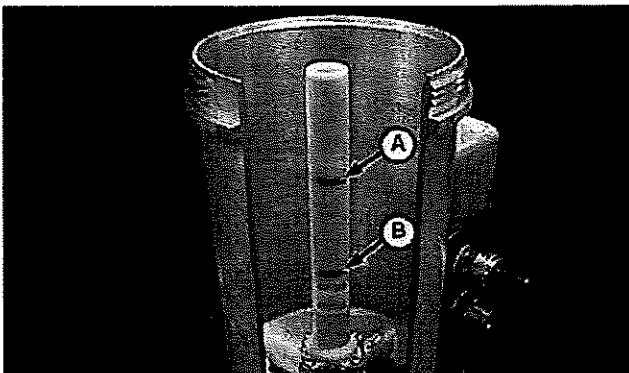

Fuel Level In Filter Housing

- A—Maximum Level (2 1/2 Inches from Top of Housing)
- B—Minimum Level (5 Inches from Top of Housing)

Figure #10F

3.1.4 Restarting Engine Which Has Run Out Of Fuel

NOTE: The procedures provided here pertain to normal initial start-up, not to the "hard starting" problem that may be associated with initial starting of engines

Note: This procedure assumes the Supply and Return lines from the fuel tank are already connected to the Supply and Return Flex Fuel Hoses on the engine.

- 1) You will need to obtain Clarke JX "Fuel Priming Assist Kit" p/n C02602 (See Figure 1).
 - A) Kit includes the following:
 - i. Quick Connect Coupling and clear plastic hose assembly (Air Bleed Tool)
 - ii. 37° flare Cap for plugging fuel return line at JIC connection on flex fuel return line hose and 1/2" npt plug for plugging fuel return line at fuel adapter fitting.

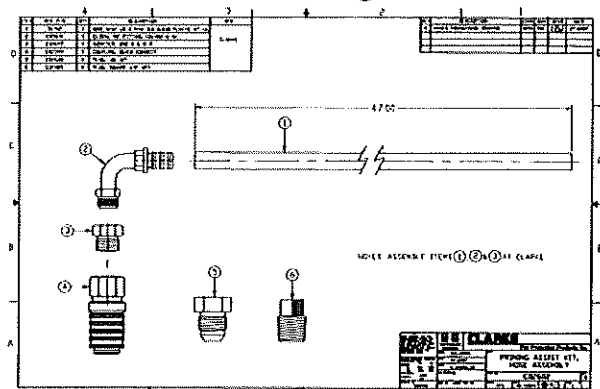
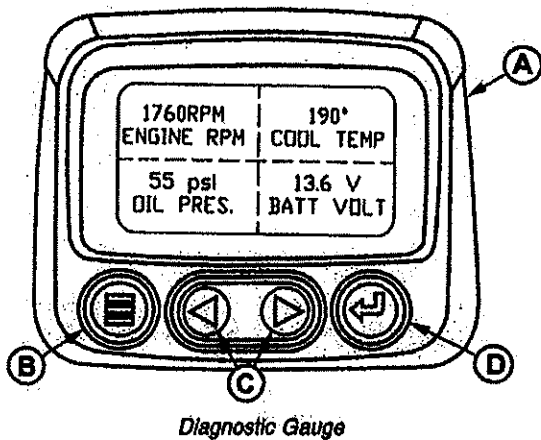

Figure 1

- 2) Change 4-up Display on Power View Display to 1-up Display in order to display fuel pressure as follows:

a) Power View Gauge in 4-Up Display Mode:



- A--Diagnostic Gauge
- B--Menu Key
- C--Arrow Keys
- D--Enter Key

4-Up Display

- b) Push the Menu Key, B, to display Menu.
 - c) Using the Arrow Keys, C, scroll down until "Set-Up 1-Up Display" is highlighted. Then push the Enter Key, D.
 - d) Using the Arrow Keys, C, scroll until "Custom Set-Up" is highlighted. Then press the Enter Key, D.
 - e) Using the Arrow Keys, C, scroll until "Fuel Pressure" is highlighted. Then press the Enter Key, D.
 - f) The Power View Gauge will now display "Fuel Pressure" only.
- 3) Close fuel supply valve at fuel tank.
 - 4) Quick-connect the Air Bleed Tool from Priming Assist Kit to the Diagnostic Port located at left rear side of fuel filter cartridge (See Figure 2). Place the clear plastic hose outlet of the Air Bleed Tool into a 5 gallon (19 liters) bucket.

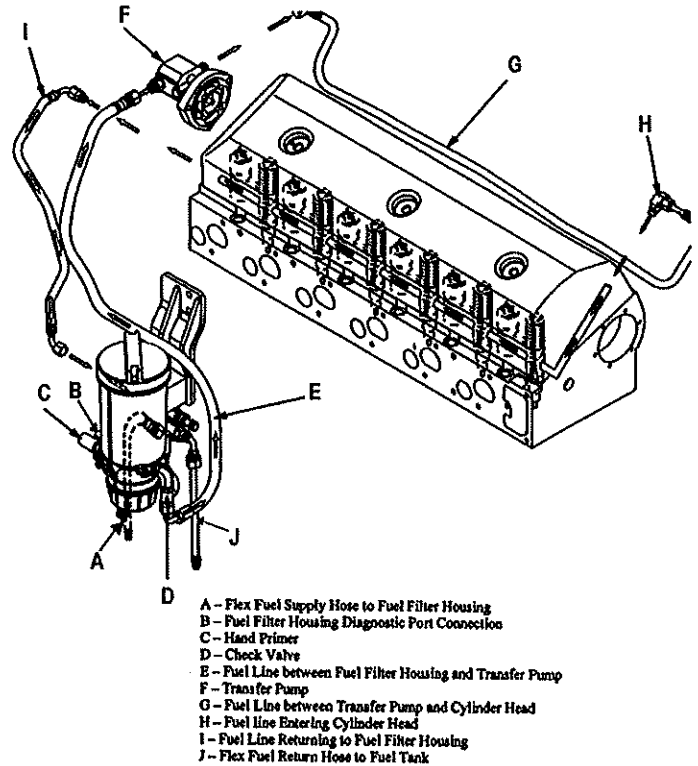

- A - Flex Fuel Supply Hose to Fuel Filter Housing
- B - Fuel Filter Housing Diagnostic Port Connection
- C - Hand Primer
- D - Check Valve
- E - Fuel Line between Fuel Filter Housing and Transfer Pump
- F - Transfer Pump
- G - Fuel Line between Transfer Pump and Cylinder Head
- H - Fuel Line Entering Cylinder Head
- I - Fuel Line Returning to Fuel Filter Housing
- J - Flex Fuel Return Hose to Fuel Tank

Figure 2

- 5) Disconnect flex fuel return line hose at swivel end and install the JIC Cap from Priming Assist Kit to plug off the fuel return line. (Alternately, remove the steel adapter fitting attached to fuel line and screw back onto flex return line hose and then install 1/2" npt plug from Priming Assist Kit to plug off fuel return line.)
- 6) Open fuel supply valve on fuel tank and let fuel flow into the engine fuel piping system.
- 7) After approximately 1 minute of gravity filling, pump the hand primer located on the front left hand side of the fuel filter cartridge roughly 200 times.

Note: As you continue to pump you should see fuel with entrained air come out of the Air Bleed Tool outlet. As you continue to pump, the amount of entrained air will be significantly reduced.

- 8) Once all the air appears to have been purged from the engine fuel piping system, quick-disconnect the Air Bleed Tool.
- 9) Proceed to then crank the engine for 20 to 30 seconds while observing the fuel pressure. Fuel pressure should gradually climb to roughly 65 psi.

Note: Fuel Return Line must be plugged by the JIC Cap from "Priming Assist Kit" (or ½" npt plug) in order to build up fuel pressure!

- 10) If engine does not start, reconnect Air Bleed Tool to Diagnostic Port on engine (same as step 4 above).
- 11) Pump the hand primer (same as step 7) approximately another 200 times.
- 12) Repeat steps 8 and 9.

Note: In order for engine to start, it requires that the engine fuel pressure stay above 60 psi for at least 15 – 20 seconds!

- 13) If engine does not start, wait 1 – 2 minutes for the electric starter motor on the engine to cool and then crank for additional 20 – 30 seconds. Observe fuel pressure - it needs to be greater than 60 psi for the engine to start. When engine starts, the fuel pressure will jump to roughly 90 – 95 psi.

Note: When engine finally starts, do not run for more than 15 to 20 seconds with the Fuel Return Line capped off. Also remember to always wait 1 to 2 minutes between each cranking cycle in order to keep starter from over-heating.

- 14) Shut down the engine
- 15) Shut off the fuel supply valve on the fuel tank.
- 16) Remove JIC cap (or 1/2" npt plug) and then reconnect the flex fuel hose to the fuel return line
- 17) Re-open the fuel supply valve at the fuel tank.
- 18) Return Power View Display to normal 4-up Display as follows:
 - a) Refer to figure 2a.
 - b) Push the Menu Key, B, to display menu.
 - c) Using the Arrow Keys, C, scroll until "Set-Up 4-Up Display" is highlighted. Then push the Enter Key, D.
 - d) Using the Arrow Keys, C, scroll until "Use Defaults" is highlighted. Then push the Enter Key, D.
 - e) The Power View Gauge will now display the normal 4-Up Display.
- 19) Engine is now primed and ready to run

3.1.5 Fuel Tanks

Keep the fuel tank filled to reduce condensation to a minimum. Open drain at the bottom of the fuel tank once a week to drain off any possible water and/or sediment. Fill tank after each test run.

Note: Per NFPA 25 standards, the fuel tank level must never be less than 67% of its capacity.

Maximum Allowable Fuel Head above Fuel pump, Supply or Return.

Engine model	feet	meters
JU4, JU6, JW6	6.6	2.0
JX6	10.7	3.3

3.2 AIR/EXHAUST SYSTEM

3.2.1 Ambient Conditions

Clarke engines are tested in accordance with SAE J1349 (Clarke USA) or ISO 3046 (Clarke UK). In this capacity they may be derated to meet certain site conditions, failure to do so can seriously impede the performance of the engine and could lead to premature failure.

3.2.2 Ventilation

The engine must be provided with adequate ventilation to satisfy the requirements of the combustion system, radiator cooling systems where fitted, and allow adequate dissipation of radiated heat and crankcase emissions. For all this data refer to Installation & Operation Data (see Page 5). This data can be used for proper sizing of inlet and outlet louvers.

3.2.3 Standard Air Filter

The standard air filter is a reusable type. Should a situation occur where the air filter becomes plugged with dirt (starving the engine of air), loss of power and heavy black smoke will result; the air filter should be serviced immediately. See *figure #21* for air filter part numbers by Clarke Engine Model.

Engine model	Air filter restriction (inches of water)
JU4H-UFAD4G	12
JU4H-UFAD5G	
JU4H-UFAD58	
JU4H-UFADJG	
JU4H-UFADP0	
JU4H-UFADR0	
JU4H-UFADW8	
JU4H-UFADY8	
JU4H-UFAD98	10
JU6H-UFADK0	
JU6H-UFADN0	
JU6H-UFAD58	
JU6H-UFADNG	
JU6H-UFADP8	
JU6H-UFAD88	
JU6H-UFADM8	
JU6H-UFADMG	14
JU6H-UFADT0	
JU6H-UFADP0	
JU6H-UFADQ0	
JU6H-UFADR0	
JU6H-UFADS0	
JU6H-UFAD98	14
JU6H-UFADR8	
JU6H-UFADS8	
JU6H-UFADW8	
JU6H-UFADX8	
JW6H-UFAD80	
JW6H-UFADB0	14
JW6H-UFADF0	
JW6H-UFADJ0	
JW6H-UFAD70	
JW6H-UFAA60	
JW6H-UFAAM8	
JW6H-UFAA80	14
JW6H-UFADD0	
JX6H-UFADF0	26
JX6H-UFAD60	
JX6H-UFADK0	
JX6H-UFADN0	
JX6H-UFADP0	
JX6H-UFAD88	

CAUTION: Do not attempt to remove the air filter while an engine is running nor run the engine while the air filter is off. Exposed components could cause severe injury to personnel and major internal engine damage could occur should any foreign matter be drawn into the engine.

The air filter manufacturer recommends the following:

- 1) The pre-oiled reusable elements are serviced with a special oil. The elements can be serviced or replaced.
- 2) *Figure #11* shows the air filter service instructions.
- 3) When servicing the element is not practical, you can improve filter efficiency by re-spraying with oil.

NOTE: Do not attempt this while engine is running
NOTE: Do not over oil the reusable element

AIR FILTER SERVICE INSTRUCTIONS



<p>1. PRE-CLEANING</p> <p>Tap the element to dislodge any large embedded dirt, then gently brush with a soft bristle brush. (Note: If complete cleaning is not practical at this time, re-oil the element and re-install in your vehicle.)</p> 	<p>2. SPRAY ON CLEANER</p> <p>Spray K&N air filter cleaner liberally onto the entire element and let soak for 10 minutes.</p> 
<p>3. PAN CLEANING</p> <p>Large K&N elements can be rolled or soaked in a shallow pan of K&N air filter cleaner. Remove immediately and let soak for approximately 10 minutes.</p> 	<p>4. CLEANING HINTS</p> <p>Use only K&N air filter cleaner.</p> <p>NO gasoline cleaning. NO steam cleaning. NO caustic cleaning solutions. NO strong detergents. NO high pressure car wash. NO parts cleaning solvents.</p> <p>Any of these NO's can cause harm to the cotton filter media, plus shrink and harden the rubber end caps.</p>
<p>5. RINSE OFF</p> <p>Rinse off the element with low pressure water. Tap water is OK. Always flush from the clean side to dirty side. This removes the dirt and does not drive it into the filter.</p> 	<p>6. DRYING HINTS</p> <p>Always dry naturally. After rinsing, shake off all excess water and let the element dry naturally.</p> <p>DO NOT USE COMPRESSED AIR DO NOT USE OPEN FLAME DO NOT USE HEAT DRYERS</p> <p>EXCESS HEAT WILL SHRINK THE COTTON FILTER MEDIA.</p> <p>COMPRESSED AIR WILL BLOW HOLES IN THE ELEMENT.</p>

Figure #11

<p>7. AEROSOL OILING</p> <p>After cleaning air filter always re-oil before using. Spray K&N air filter oil down into each pleat with one pass per pleat. Wait 10 minutes and reoil any white spots still showing.</p> 	<p>8. SQUEEZE BOTTLE OILING</p> <p>After cleaning air filter always re-oil before using. Squeeze K&N air filter oil down into the bottom and along each pleat — only one pass per pleat. Let oil wick into cotton for 20 minutes. Re-oil any white spots still showing.</p> 
<p>9. OILING HINTS</p> <p>Never use a K&N air filter without oil. <i>(The filter will not stop the dirt without the oil.)</i> Use only K&N formulated air filter oil. K&N air filter oil is a compound of mineral and animal oil blended with special polymers to form a very efficient tack barrier. Red dye is added to show just where you have applied the oil. Eventually the red color will fade but the oil will remain and filter the air.</p> <p>NEVER USE Automatic Transmission Fluid. NEVER USE Motor Oil. NEVER USE Diesel Fuel. NEVER USE WD-40, LPS, or other light weight oils.</p>	

Figure #11 Cont'd

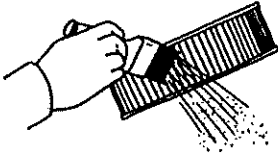
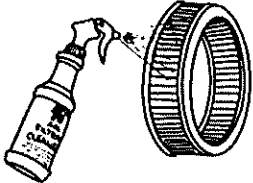
Note: Intake Air Shutoff Valve - Engine may include an intake air shutoff valve as an optional feature that is activated by an overspeed event and provides a positive shutoff of combustion air to the engine. The optional air intake shutoff valve has not been evaluated by UL as part of a UL Listed fire pump driver.

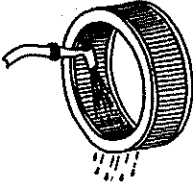
3.2.4 Crankcase Ventilation

Vapors which may form within the engine are removed from the crankcase and gear train compartment by a continuous, pressurized ventilation system. A slight pressure is maintained within the engine crankcase compartment. Vapors are expelled through a vent pipe attached to the rocker cover breather element. Ref. Figure #12.



Figure #12

3.2.5 Exhaust System

Excessive back pressures to the engine exhaust can considerably reduce both engine performance and life. It is therefore important that exhaust systems should be the proper diameter and be as short as possible within the minimum amount of bends. Refer to Installation & Operating Data (see Page 5) for exhaust data. Also refer to the table below for maximum exhaust restrictions.

Engine model	Exhaust backpressure limit (inches of water)
JU4H-UFAD4G	30
JU4H-UFAD5G	
JU4H-UFAD58	
JU4H-UFADJG	
JU4H-UFADP0	
JU4H-UFADR0	
JU4H-UFADW8	
JU4H-UFADY8	
JU4H-UFAD98	
JU6H-UFADK0	30
JU6H-UFADN0	
JU6H-UFAD58	
JU6H-UFADNG	
JU6H-UFADP8	
JU6H-UFAD88	
JU6H-UFADM8	
JU6H-UFADMG	

Engine model	Exhaust backpressure limit (inches of water)
JU6H-UFADT0	30
JU6H-UFADP0	
JU6H-UFADQ0	
JU6H-UFADR0	
JU6H-UFADS0	
JU6H-UFAD98	30
JU6H-UFADR8	
JU6H-UFADS8	
JU6H-UFADW8	
JU6H-UFADX8	
JW6H-UFAD80	30
JW6H-UFADB0	
JW6H-UFADF0	
JW6H-UFADJ0	
JW6H-UFAD70	
JW6H-UFAA60	
JW6H-UFAAM8	
JW6H-UFAA80	
JW6H-UFADD0	30
JX6H-UFADF0	40
JX6H-UFAD60	
JX6H-UFADK0	
JX6H-UFADN0	
JX6H-UFADP0	
JX6H-UFAD88	

2) White Smoke – Possibility of water in cylinders, water in fuel or internal engine problem.

3.3 LUBRICATION SYSTEM

3.3.1 Checking Sump Oil

Check the sump oil level using the dipstick on the engine as shown in *Figure #13*.



JU

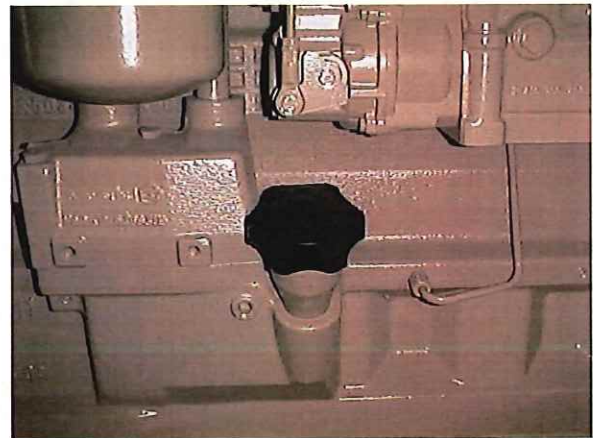

JW

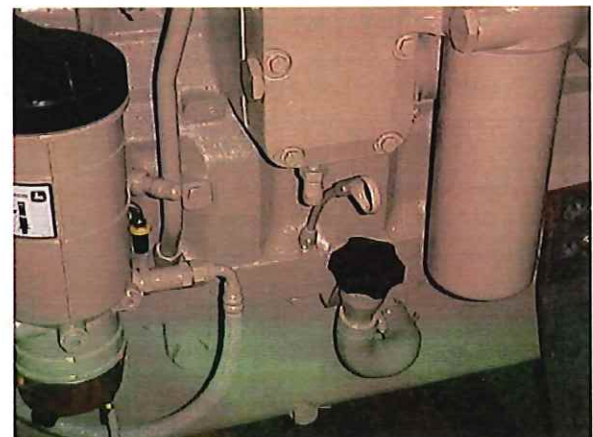

JX

Figure #13

The installation of the exhaust system should consist of the following:

- Personnel protection from hot surfaces.
- Adequate supports to prevent strain on the engine exhaust outlet and minimize vibration.
- Protection against entry of water and other foreign matter.

While the engine is running inspect exhaust pipe outlet outside of the pump room itself for environmental hazards such as excessive smoke conditions. The following could be used as a guide for general engine operating conditions.

1) Blue Smoke – Possible engine oil consumption.

This level must always be between the dipstick marks Min. and Max. with the engine not running.

3.3.2 Changing Engine Oil

- 1) Operate the engine until it is warm.
- 2) Stop the engine. Remove the sump drain plug and drain the lubricating oil from the sump. Fit the drain plug and tighten the plug to 34 Nm (25lb-ft) (3.5 kgf-m).
- 3) Fill the sump to the 'FULL' mark on the dipstick with new and clean lubricating oil of an approved grade.
- 4) Dispose used oil properly.

3.3.3 Changing Oil Filter Cartridge

- 1) Put a tray under the filter to retain spilt lubricating oil.
- 2) Remove the filter with a strap wrench or similar tool. Then dispose of the filter properly.
- 3) Clean the filter head.
- 4) Add clean engine lubricating oil to the new filter. Allow the oil enough time to pass through the filter element.
- 5) Lubricate the top of the filter seal with clean engine lubricating oil.
- 6) Fit the new filter and tighten it by hand only. Do not use a strap wrench.
- 7) Ensure that there is lubricating oil in the sump. On turbocharged engines, ensure that the engine will not start and operate the starter motor until oil pressure is obtained.
- 8) Operate the engine and check for leakage from the filter. When the engine has cooled, check the oil level on the dipstick and put more oil into the sump, if necessary.
- 9) Return the unit back into service by returning the main pump controller selector to "automatic" position and the manual operating lever to AUTO-OFF position.

3.3.4 Oil Specification

Diesel Engine Oil

This engine is factory-filled with John Deere Engine Break-in Oil.

Important: Do not add makeup oil until the oil level is BELOW the add mark on dipstick. John Deere Engine Break-In Oil (TY26661) should be used to make up any oil consumed during the

break-in period. Break-in period is 1 year from engine start-up.

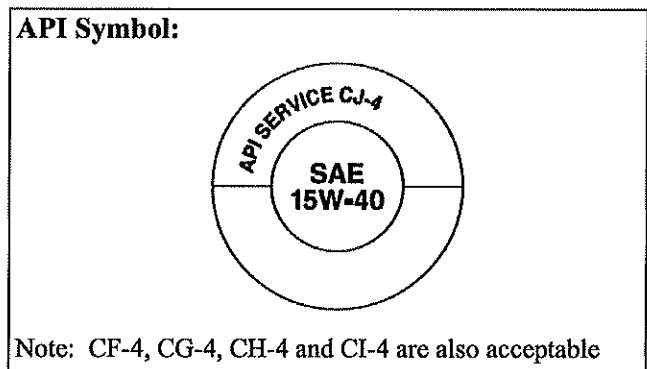

Figure #15

3.3.5 Oil Capacities (Including Filter)

ENGINE MODEL	OIL CAPACITY QUARTS (LITERS)
JU4 – All Models	15.5 (14.7)
JU6 – All Models (Except JU6H-PTP models listed below)	21.1 (20)
JU6 – PTP (JU6H-UFAD98, ADP0, ADQ0, ADR0, ADR8, ADS0, ADS8, ADT0, ADW8, ADX8)	34.3 (32.5)
JW6 – All Models	30.1 (28.5)
JX6H – All Models	44.7 (42.3)

Figure #16

3.4 COOLING SYSTEM

3.4.1 Intended Engine Operating Temperature

The JU, JW, and JX engines are provided with either a heat exchanger or radiator to maintain the engine coolant temperature within recommended operating guidelines.

The JU4H, JU6H, and JW6H have an intended engine operating temperature of 175° F (79°C) to 195° F (91° C). A high coolant temperature sensor monitors coolant temperature and will set an alarm at 230° F (110° C).

3.4.2 Engine Coolant

The following information is provided as a guide for John Deere Engine users in the selection of a suitable coolant.

The water/ethylene glycol/inhibitor coolant mixture used in John Deere engines must meet the following basic requirements:

- Provide for adequate heat transfer.
- Provide protection from cavitation damage.
- Provide a corrosion/erosion-resistant environment within the cooling system.
- Prevent formation of scale or sludge deposits in the cooling system.
- Be compatible with engine hose and seal materials.
- Provide adequate freeze and boil over protection.

WARNING

A water and anti-freeze solution is required for pump installations. Premixing this solution prior to installing is required. This prevents possible pure anti-freeze chemical reactions to block heater elements which can burnout the element. Please see the I&O section (see Page 5) for proper cooling system capacities of each model.

3.4.3 Water

Water can produce a corrosive environment in the cooling system, and the mineral content may permit scale deposits to form on internal cooling surfaces. Therefore, inhibitors must be added to control corrosion, cavitation, and scale deposits.

Chlorides, sulfates, magnesium and calcium are among the materials which make up dissolved solids that may cause scale deposits, sludge deposits, corrosion or a combination of these. Chlorides and/or sulfates tend to accelerate corrosion, while hardness (percentage of magnesium and calcium salts broadly classified as carbonates) causes deposits of scale. Water within the limits specified in *figure #17* is satisfactory as an engine coolant when properly inhibited. Use of distilled water is preferred.

Materials	Parts per Million	Grains per Gallon
Chloride (Max.)	40	2.5
Sulfates (Max.)	100	5.8
Total Dissolves Solids (Max.)	340	20
Total Hardness (Max.)	170	10

Figure #17

3.4.4 Coolant Capacities

Ethylene Glycol or Propylene Glycol are acceptable:

IMPORTANT:

Do not use cooling system sealing additives or antifreeze that contains sealing additives.

Do not mix ethylene glycol and propylene glycol base coolants.

Do not use coolants that contain nitrites.

Use an ethylene glycol coolant (low silicate formulation) that meets the standard of either the GM 6038-N formulation (GM1899-M performance) or **ASTM D6210** requirements.

A 50% coolant water solution is recommended. A concentration over 70% is not recommended because of poor heat transfer capability, adverse freeze protection and possible silicate dropout. Concentrations below 30% offer little freeze, boil over or corrosion protection.

IMPORTANT

Never use automotive-type coolants (such as those meeting only ASTM D3306 or ASTM D4656). These coolants do not contain the correct additives to protect heavy-duty diesel engines. They often contain a high concentration of silicates and may damage the engine or cooling system.

ENGINE MODEL	COOLANT CAPACITY QUARTS (LITERS)
JU4H-All Models	15 (14.2)
JU6H-All Models	20 (19)
JW6-All Models	23 (22)
JX6H-All Models	29.6 (28)

Figure #18

3.4.5 Coolant Inhibitors

The importance of a properly inhibited coolant cannot be over-emphasized. A coolant which has insufficient or no inhibitors at all, invites the formation of rust, scale, sludge and mineral deposits. These deposits can greatly reduce the cooling systems efficiency and protection capabilities. Recommended supplemental coolant inhibitors are a combination of chemical compounds which provide corrosion protection, cavitation suppression, pH controls and prevents scale. These inhibitors are

available in various forms, such as liquid packages or integral parts of anti-freeze.

It is imperative that supplemental inhibitors be added to all John Deere engine systems. A pre-charge dosage must be used at the initial fill and the maintenance dosage used at each service interval. Serious damage will occur unless inhibitors are used. Some of the more common corrosion inhibitors are borates, nitrates and silicates.

Inhibitors become depleted through normal operation; additional inhibitors must be added to the coolant as required to maintain original strength levels. Refer *Figure #19* for proper concentrations of inhibitors.

	Min. PPM	Max PPM
Boron (B)	1000	1500
Nitrite (NO ²)	800	2400
Nitrates (NO ³)	1000	2000
Silicon (Si)	50	250
Phosphorous (P)	300	500
PH	8.5	10.5

Figure #19

Do not use soluble oils or chromate inhibitors in John Deere engines. Detrimental effects will occur.

To properly check inhibitor concentrations it may be necessary to contact your local Service/Dealer for assistance. Refer to Parts Information Section to obtain the part number for the factory Coolant Analysis Kit. This kit can be purchased for a nominal fee for analyzing the conditions of the engine's coolant.

3.4.6 Procedure for Filling Engine

During filling of the cooling system, air pockets may form. The system must be purged of air prior to being put in service. This is best accomplished by filling with a pre-mix solution. Refer to *Figure #19A* for proper fill level.

Caution: Do not overfill cooling system. A pressurized system needs space for heat expansion without overflowing.

Install the pressure cap, start and run engine for approximately 5 minutes in order to purge the air from the engine cavities.

When verifying that the coolant is at a safe operating level, it is best to wait until the engine temperature

drops to approximately 120°F (49°C), or lower, before removing the pressure cap.

Remove the pressure cap and refill to the proper fill level. To continue the deaeration process start and run engine until the temperature stabilizes at approximately 160°-200° (71°-93° C) or run engine for 25 minutes, whichever is longer. During this warming process, you may see coolant coming from the overflow tube attached at the pressure cap location. Allow engine to cool, then remove the pressure cap and refill to the proper fill level.

Caution: Do not remove pressure cap while coolant is at normal operating temperatures. Possible personal injury could result from the expulsion of hot coolant.

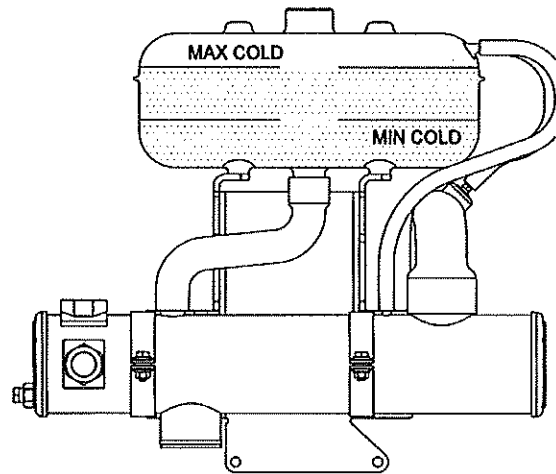

HEAT EXCHANGER WITH SEPARATE EXPANSION TANK WITHOUT DOWN TUBE

Figure 19A

3.4.7 Providing Adequate Raw Water Supply to the Engine Heat Exchanger

3.4.7.1 Raw Water Supply

Most Clarke diesel engine fire pump drivers are heat exchanger cooled and some engines also have a charge air cooler (CAC) that uses raw water to cool the air before entering the intake manifold. If you have a radiator cooled Clarke engine, you can disregard this section. Heat exchanger cooled diesel engine drivers require a clean source of pressurized water from the discharge side of the fire pump in order to keep the engine from overheating by providing a specified minimum amount of raw water flow.

3.4.7.2 Cooling Loop

Note: Engine may include a cooling loop as an optional feature and has not been evaluated by UL as part of a UL Listed fire pump driver.

Clarke cooling loops are FM Approved to meet standard sizing conditions of 50% blocked wye strainers, 100degF (38degC) raw water inlet temperature, 80 psi inlet pressure, and 10 psi available at the engine outlet.

Figure #26 shows the standard NFPA 20 cooling loop piping arrangement. The cooling loop consists of an Automatic flow line with a 12v or 24v solenoid valve (HSC and ES pump applications only) that is energized to open anytime the engine is called upon to run from either the fire pump controller or from the engine instrument panel.

NOTE: VT type pump applications do not require a solenoid valve in the Automatic flow line.

NOTE: With the Mechanical Engine and Alarm Control Board, See section 3.5.5, the solenoid valve will open 15 seconds after engine shutdown and will stay open for 60 seconds. This allows for raw water to flow through the heat exchanger and reduce the heat soak rise caused in the engine.

The second flow line is called the Manual by-pass line and it can be opened at any time if for any reason the engine shows signs of overheating. Each line has two (quarter turn) shutoff valves installed and the normal position of the shutoff valve is to remain open in the Automatic flow line and remain closed in the Manual by-pass flow line.

NOTE: Opening up both lines to flow is never a problem should there be some concern of engine overheat, especially if there is an emergency

situation. The Manual by-pass line can only be opened by an operator in the pump room.

The shutoff valves are all identified to show which are Normally Open (Automatic flow line) and which are Normally Closed (Manual by-pass flow line). The shutoff valves are also used to isolate water pressure in the event of maintenance to pressure regulators, strainers and solenoid valve. Shut off valves in the Automatic flow line are provided with lockable handles for cooling loops that have been tested to FM requirements.

In each flow line there is also a pressure regulator. Each pressure regulator protects the downstream piping from over-pressurization which includes the tube side of the engine shell & tube heat exchanger (and/or CAC) and to control raw water flow rate. The pressure regulators are set to limit downstream pressure to 60 psi (4 bar). There is a 0-60 psi (0-4 bar) pressure gauge installed at the cooling loop outlet, and prior to the engine heat exchanger (or CAC).

Wye strainers are used to remove debris from the raw water supply. One strainer is in the Automatic flow line and the other is in the Manual by-pass flow line. Note: See section 3.4.7.5 regarding strainer maintenance.

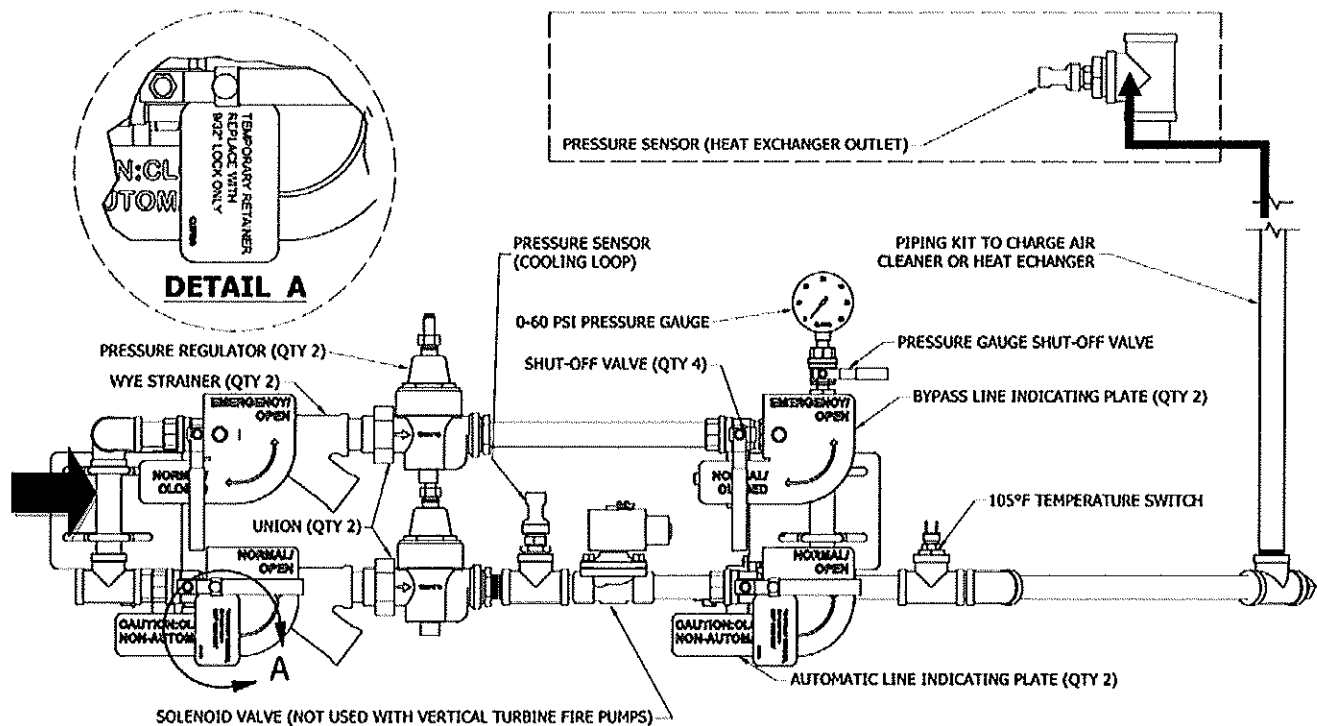

Figure #26

3.4.7.3 Setting Raw Water Flow Rate

The proper amount of raw water flow thru the engine is of the utmost importance, and the pressure gauge value does little to indicate if there is sufficient flow. When the engine is exercised weekly, the amount of raw water flow exiting the engine should always be checked to verify it does not appear to have diminished.

During initial commissioning of the engine, it is important to correctly set the raw flow rate going thru the cooling loop. Each Clarke engine model has an Installation and Operation (I&O) Datasheet that provides basic operating conditions of the engine and most values are given based upon engine speed. You will find this datasheet in the documentation bag that is shipped with the engine for your specific Clarke model. This datasheet must be available during commissioning in order to set the proper minimum raw water flow. With the fire pump flowing 150% of rated flow, and the Automatic flow line open; verify sufficient raw water flow rate is achieved and that the reading of the cooling loop pressure gauge does not exceed 60 psi (4 bar). You will need to capture the flow for a specific amount of time coming out of the heat exchanger and going to a floor drain in order to establish a reasonably accurate flow rate value. Using a container or bucket of known volume, record the time required to fill the container and compare to the

gpm or L/min value provided on the I&O datasheet. ***THIS IS CRITICAL FOR PROPER ENGINE COOLING AT MAXIMUM PUMP LOAD!!***

If proper cooling water flow rate is established then no fire pump controller alarm will be triggered to indicate clogged raw water strainer (low raw water flow).

After verifying raw water flow rate in the Automatic flowline, open the Manual by-pass line shut-off valves, and then close the Automatic flowline shut-off valves and repeat the above process in order to verify the flowrate going thru the Manual by-pass line. Note, with Automatic flowline closed the controller low raw water flow alarm may be present, this is normal. Once this is completed; close the Manual by-pass shut-off valves and open the Automatic flowline shut-off valves to restore conditions back to normal.

3.4.7.4 Raw Water Outlet

NOTE: NFPA 20 does allow for the heat exchanger outlet flow to be returned to a suction reservoir. This makes it very difficult to measure the flowrate. When discharging to a suction reservoir, NFPA provides additional requirements:

- 1) A visual flow indicator and temperature indicator are installed in the discharge (waste outlet) piping.

- 2) When waste outlet piping is longer than 15ft (4.6m) and / or the outlet discharges are more than 4ft (1.2M) higher than the heat exchanger, the pipe size increased by at least one size.
- 3) Verify that when the correct flow rate is achieved that the inlet pressure to the heat exchanger (or CAC) does not exceed 60psi (4bar)

If you have such an installation, it is recommended that you run the engine for a period of time at firepump 150% flow and confirm the visual flow indicator is showing water flow, the temperature rise is not excessive (usually no more than 40F (4.5C) over ambient raw water temperature) and the engine is showing no signs of overheating.

3.4.7.5 Raw Water Quality Strainers and Deterioration of Heat Exchanger (or CAC)

Over time, as the heat exchanger (or CAC) begins to plug and foul, this pressure will rise and the flow will diminish which could mean that the heat exchanger (or CAC) may have to be replaced.

It can be not stressed enough how important it is to keep the wye strainers within the cooling loop clean: **Most engine failures occur due to plugged cooling loop strainers!** If the raw water supply has debris in it (leaves, stones, etc) as the strainer accumulates more debris (that will not pass thru it), the flowrate will continue to diminish which will eventually starve the engine of adequate cooling water flow which will lead to engine overheat and catastrophic engine failure. **When this occurs you have no fire protection!** Clarke recommends that after the initial engine commissioning and also prior to each weekly exercise of the engine / fire pump set, both strainers be removed and cleaned and then re-installed before starting the engine.

Clarke engines are equipped with an alarm that is meant to signal diminished raw water flow rate (terminal 311), possibly due to clogged raw water strainers in the cooling loop. Refer to Figures 26 and 26A1 for location of sensors. A circuit board located near the front of the cooling loop monitors differential pressure between the two sensors and will send an alarm to the controller if a low water flow condition exists.

Additionally, a raw water temperature switch will send an alarm (terminal 310) when temperature of the

water exceeds 105°F (41° C). Refer to Figures 26 and 26A1 for location of switch. If either of these alarms are active, it indicates that the cooling system's capability may be compromised.

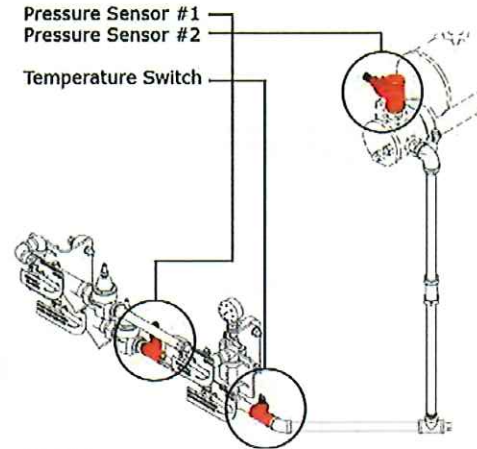

Figure #26A1

3.4.7.6 Backflow Preventers

NFPA20 allows for the use of backflow preventers in the Automatic and Manual flow line of the cooling loop as required by local code. For specific application information contact factory.

3.4.7.7 Raw Water Outlet Temperature

Certain local codes may not allow you to discharge the waste water outlet from the engine heat exchanger either due to its temperature or it now being considered hazardous waste. It is recommended you always check local codes regarding waste water discharge.

3.4.8 Flow Paths of Engine Cooling System

The engine coolant flows through the shell side of the heat exchanger (or radiator), engine coolant pump, oil cooler, engine block and cylinder head, jacket water heater, thermostat, expansion tank, and coolant recovery tank (if equipped).

On heat exchanger equipped engines raw cooling water flows through the tube side of the charge air cooler, if equipped, and the tube side of the heat exchanger.

Refer to *Figures #35E* for heat exchanger cooled engines and *#35F* for radiator cooled engines for cooling system flow path diagrams.

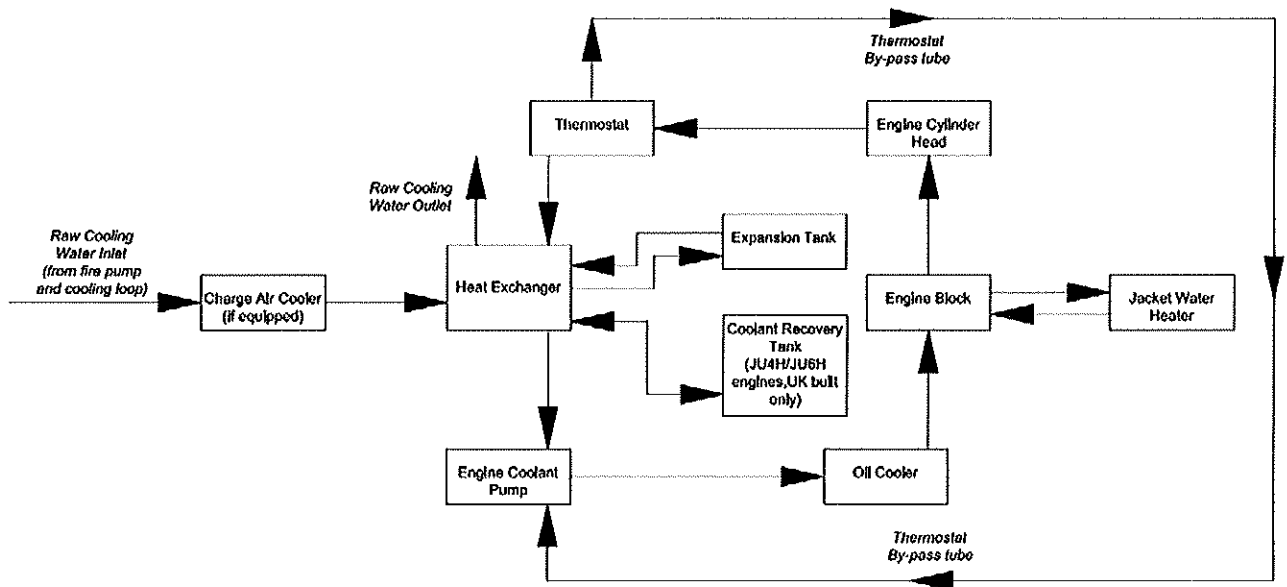

Figure 35E – Heat Exchanger cooled engines

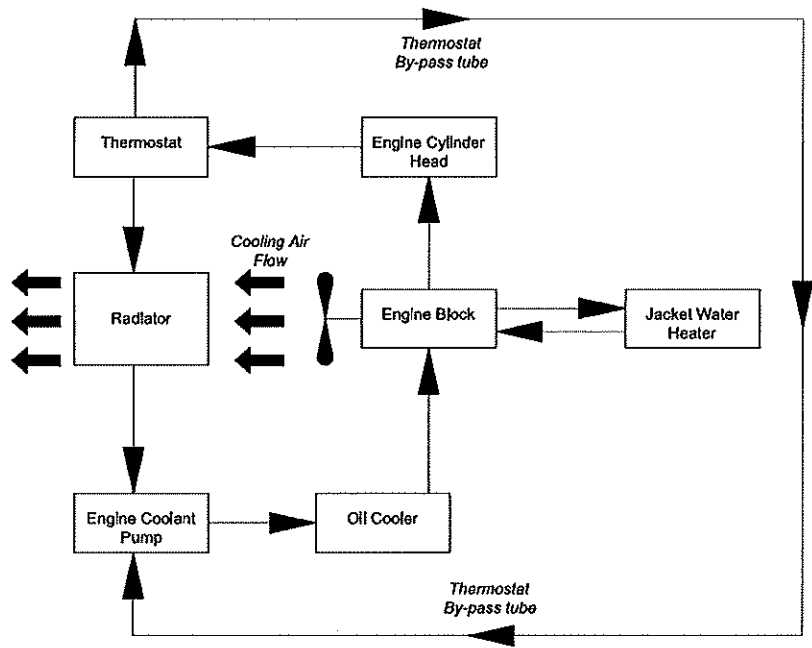

Figure 35F- radiator cooled engines

3.4.9 IMPORTANT SERVICE NOTICE

Any time an engine experiences a high coolant temperature alarm condition the primary cause of the overheat must be determined and the cause corrected to prevent a recurring overheat event.. Additionally, if an event of a restricted flow, collapsed hose, insufficient coolant level or failed pressure cap is experienced, further investigation of the cooling system is required.

- 1) The coolant should be drained (after de-energizing the coolant heater
- 2) Replace the engine thermostat(s)
- 3) Remove the engine water pump and inspect the impeller and seal for damage, replace as necessary. Reassemble and refill coolant according to the Installation and Operations Instruction Manual.
- 4) Run the engine to verify normal operating temperature.

3.4.9.1 Water Pump Cavitation

Cavitation is a condition that occurs when bubbles form in the coolant flow in the low pressure areas of the cooling system and implode as they pass to the higher pressure areas of the system. This can result in damage to cooling system components, particularly the water pump impeller and cylinder liners.

Cavitation in an engine can be caused by:

- Improper coolant
- Restricted coolant flow caused by collapsed hose or plugged system
- Coolant fill cap is loose or unable to retain the required pressure
- Insufficient fluid level
- Failure to de-aerate
- Overheat

3.5 ELECTRICAL SYSTEM

3.5.1 Wiring Diagrams (Only with Engine Gauge Panel)

Drawing No.	Description (DC Voltage)	Reference Document
C072200	Instrument Panel	
C071361	ECM Harness	
C071367	JU4H-UFAD4G, UFAD5G, UFAD58, UFADJG, UFADP0, UFADR0, UFADW8, UFADY8, UFAD98 JU6H-UFADK0, UFADN0, UFAD58, UFADNG, UFADP8 UFAD88, UFADM8, UFADMG Engine Harness	
C071368	JU6H-UFADT0, UFADP0, UFADQ0, UFADR0, UFADS0, UFAD98, UFADR8, UFADS8, UFADW8, UFADX8 Engine Harness	
C071369	JW6H-UFAD80, UFADB0, UFADF0, UFADJ0, UFAD70 JW6H-UFAAM8,80 Engine Harness	
C071370	JW6H-UFADD0 Engine Harness	

C071371	JX6H-UFADF0, UFAD60, UFADK0, UFADN0, UFADP0, UFAD88 Engine Harness	
---------	-----------------------------------------------------------------------	--

Drawing No.	Description (AC Voltage)	Reference Document
C07651 (JW/JX) C07591 (JU)	Jacket Water Heater (NL Models Optional)	

Figure #20

3.5.2 Checking Drive Belt Tension and Adjustment

All drive belts must be adequately tightened to secure that both the engine water pump and battery charging alternator (when fitted) are operating efficiently. Refer to *Figure #37*.

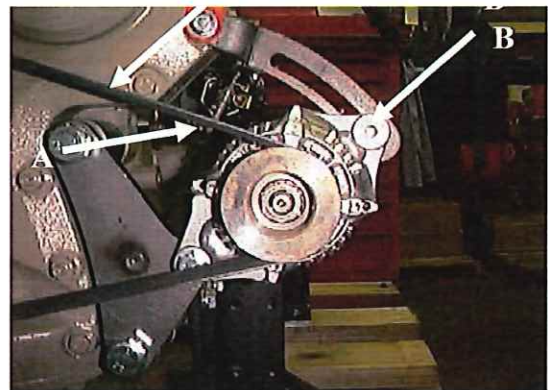

Figure #37

To adjust Belt Tension:

Check belt tension:

- Give at arrow must be .4" - .6" (10-15mm).

To increase tension of the water pump driving belts:

- Loosen alternator or belt tensioner mounting bolts A and B.
- Adjust to proper belt tension.
- Tighten mounting bolts A and B.

JX units equipped with automatic tensioner. No belt adjustment is required.

3.5.3 Engine Overspeed

In the event of an engine overspeed, the ECM signals the main pump controller and also affects an engine shutdown. Should an overspeed condition occur, investigate the cause and make necessary corrections before placing engine back in service. The overspeed reset switch must be manually lifted for 30 seconds to reset.

OVERSPEED VERIFICATION

Hold the OVERSPEED VERIFICATION switch in the “up” position. This will provide the main pump controller with an overspeed signal and engine shutdown at 30 RPM’s below the rated RPM.

Start the engine via the main pump controller; the speed switch will generate an overspeed signal and shutdown protecting both the engine and pump.

EXAMPLE

Rated Speed: 1760 RPM

Overspeed Shutdown: 2112 RPM (120% of 1760 RPM)

Verification Shutdown: 1730

CAUTION-after verification of overspeed, lift the OVERSPEED RESET switch and reset the main pump controller to re-instate normal operation of the engine and speed switch.

The over speed shut down set point is factory set, programmed into the ECM, and not field adjustable.

Caution: Do not attempt to overspeed the engine to verify overspeed shutdown.

3.5.4 Field Simulation of Pump Controller Alarms

Field simulation of pump controller alarms – Refer to supplemental document C134335 for additional information.

- Alarm 1: Over speed Shutdown: Follow over speed verification steps above.
- Alarm 2: Low Oil Pressure: With the engine running, lift the low oil pressure switch. (Note: There is no engine mounted Low Oil Pressure switch to jumper across).
- Alarm 3: High Engine Coolant Temperature: With the engine running, lift high water temperature switch. (Note: There is no engine mounted High Coolant Temperature switch to jumper across).
- Alarm 4: Overcrank: Lift and hold the MANUAL STOP SWITCH to prevent the engine from starting during the cycle-crank testing. NEVER shut off the fuel supply to the engine to prevent it from starting. Shutting off the fuel supply will cause an air lock condition in the fuel system

and possibly cause fuel system component damage.

- Alarm 5: Low Engine Coolant Temperature: With engine at rest, lift low coolant temperature switch for 25 seconds.
- Alarm 6: ECM Warning: Lift the Manual Stop switch for 2 minutes with engine not running to verify ECM Warning Alarm; note engine will automatically switch to alternate ECM.
- Alarm 7: ECM Failure: After ECM Warning Alarm has been tested, continue lifting Manual Stop Switch for additional 2 minutes with engine not running to verify ECM Failure Alarm.
 1. After activation of both ECM Warning and Failure Alarms, activate the ECM Failure Reset Switch inside the engine control panel.

3.5.5 Battery Requirements

All Clarke engine models require 8D batteries, as sized per SAE J537 and NFPA20. The battery should meet the following criteria:

Cold Cranking Amps (CCA @ 0°F): 1400
Reserve Capacity (minutes): 430

Refer to Clarke drawing C131885 (see Page 5) for additional information on Clarke supplied batteries.

3.6 ENGINE SPEED ADJUSTMENT

All governor and speed control functions are programmed into each ECM at the factory. During Start-Up Inspection, some minor speed adjustment may be required.

To adjust the speed of the engine:

- A. Start the engine by following the “To Start Engine” Procedure in this manual.
- B. Let the engine warm-up. Open engine gauge panel.
- C. While observing the tachometer, lift and hold the speed change enable switch. Toggle speed adjustment switch up or down to increase or reduce speed. (Refer to Figure # 20A below).
- D. Stop engine by following “To Stop Engine” Procedure in this manual.
- E. Switch to Alternate ECM and repeat steps A through D.

- F. Stop engine by following "To Stop Engine" Procedure in this manual.
- G. Switch back to Primary ECM.
- H. Close panel door, replace door retaining screws.

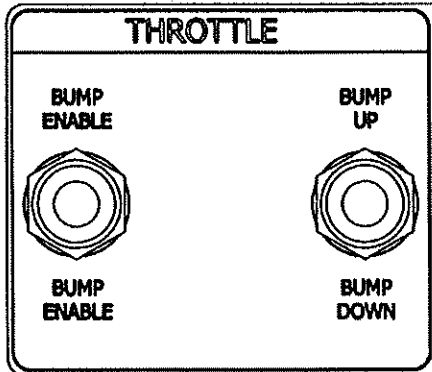

Figure #20A

4.0 MAINTENANCE SCHEDULE

4.1 ROUTINE MAINTENANCE

NOTE: The following Routine Maintenance schedule is based on an engine usage rate not exceeding 2 hours per month. For UL/FM engine models, also refer to NFPA25.

LEGEND:

- Check
- ❖ Clean
- Replace
- Lubricate

WEEKLY

- Air Filter
- Battery
- Coolant Hoses
- Coolant Levels
- Cooling Water Solenoid Valve
- Exhaust System
- Fuel Tank
- General Inspection
- Governor Run-Stop Control
- Jacket Water Heater
- Lubrication Oil Level
- Operating Gauges
- Remove Water from Fuel Filter
- Run Engine
- Warning Light

EVERY 6 MONTHS

- ❖ Batteries
- Battery Charging Alternator
- Belts
- ❖ Cooling Water Strainers
- Driveshaft U-Joints
- Fuel Lines

EVERY 1 YEAR

- ❖ Air Filter
- ❖ Fuel Lift Pump Strainer
- Coolant Inhibitor
- Crankcase Vent System
- Driveshaft U-Joints
- Fuel & Oil Filters
- Heat Exchanger Electrode
- Lubricating Oil
- Mounting Isolators
- Wiring System

EVERY 2 YEARS

- Air Filter
- Batteries
- Belts
- Coolant Hoses
- Coolant
- Thermostat

IMPORTANT: Set main pump controller to "OFF" while servicing engine. Before turning the main pump controller to the "OFF" position, check with the maintenance and security supervisors to verify that all the departments concerned will be alerted of the temporary interruption of their fire protection equipment for normal maintenance or testing. Also, alert the local fire department in the event that the main pump controller is connected by silent alarm to headquarters. When servicing is complete, return main pump controller selector to "Automatic" position and the mode selector on the engine to "Automatic" position. Advise the appropriate personnel the engine has been returned to the "Automatic".

5.0 TROUBLE SHOOTING

General Troubleshooting Information

Troubleshooting engine problems can be difficult.

The engine control unit (ECM) has the ability to detect problems internally and in the electronic control system. This includes determining if any of the sensor input voltages are too high or too low, if the camshaft and crankshaft position sensor inputs are valid, and if the unit injector solenoids are responding properly.

If the ECM detects a problem with the electronic control system a diagnostic trouble code (DTC) specific to the failed system will be stored in the ECM's memory.

5.1 DIAGNOSTIC TROUBLE CODES (DTC's)

There are two types of DTC's

- Active
- Inactive (stored)

Active DTCs indicate that the failure is occurring. These type of failures are sometimes called "hard" failures. They can be accessed on the diagnostic gauge (A) on the instrument panel.

Inactive DTCs indicate that a failure has occurred in the past, but is not currently occurring. This type of "stored" DTC can be caused by an "intermittently" failure. These could be problems such as a bad connection or a wire intermittently shoring out.

If a sensor or wiring fails and a DTC is active for the sensor, the ECM will use a substitute "limp home" value in its calculation to continue engine operation. Displaying of Diagnostic Trouble Codes (DTCs) SPN/FMI CODES

Stored and active diagnostic trouble codes are output on the PowerView Gauge according to the J1939 standard as a two-part code as shown on the table on the following pages.

The first part is a Suspect Parameter Number (SPN) followed by a Failure Mode Identifier (FMI) code. In order to determine the exact failure, both (SPN and FMI) of the code are needed.

The SPN identifies the system or the component that has the failure; for example SPN 000110 indicates a failure in the engine coolant temperature circuit.

The FMI identifies the type of failure that has occurred; for example FMI03 indicates value above normal. Combining the SPN 000110 with FMI 03 yields engine coolant temperature input voltage too high.

Always contact your Clarke service dealer for help in correcting diagnostic trouble codes which are displayed for your engine.

Listing of Diagnostic Trouble Codes (DTCs)

The Diagnostic Trouble Codes (DTCs) are output on the diagnostic gauge according to J1939 standard as a two-part code. The first part is a two to four-digit Suspect Parameter Number (SPN) followed by a one or two-digit Failure Mode Identifier (FMI) code.

Following is a list of SPN's, FMI's and a description of the diagnostic trouble codes that can occur in the various engine systems. Not all of these codes will be present in all engine applications.

When trouble codes appear on the PowerView diagnostic gauge, see your engine dealer for repairs as soon as possible.

Listing of Diagnostic Trouble Codes		
SPN	FMI	Description
28	03	Throttle #3 Input High
28	04	Throttle #3 Input Low
29	03	Throttle #2 Input High
29	04	Throttle #2 Input Low
91	03	Throttle #1 Input High
91	04	Throttle #1 Input Low
91	08	PWM Throttle Abnormal Pulse Width
91	09	Throttle Invalid
91	14	Throttle Voltage Out of Range
94	01	Fuel Supply Pressure Extremely Low
94	03	Fuel Supply Pressure Input Voltage High
94	04	Fuel Supply Pressure Input Voltage Low
94	16/31	Fuel Supply Pressure Moderately High
94	18	Fuel Supply Pressure Moderately Low
97	00	Water in Fuel – Continuously Detected
97	03	Water in Fuel Signal – Voltage High
97	04	Water in Fuel Signal – Voltage Low
97	16	Water in Fuel Detected
100	01	Engine Oil Pressure Extremely Low
100	03	Engine Oil Pressure Input Voltage High
100	04	Engine Oil Pressure Input Voltage Low
100	18	Engine Oil Pressure Moderately Low
102	03	Manifold Air Pressure Input Voltage High
102	04	Manifold Air Temperature Input Voltage Low
105	03	Manifold Air Temperature Input Voltage High
Listing of Diagnostic Trouble Codes		
105	04	Manifold Air Temperature Input Voltage Low
105	16	Manifold Air Temperature Input Voltage High
110	00	Engine Coolant Temperature Extremely High
110	03	Engine Coolant Temperature Input Voltage High
110	04	Engine Coolant Temperature Input Voltage Low
110	16	Engine Coolant Temperature

		Moderately High
111	01	Engine Coolant Level Low
158	17	ECM Power Down Error
174	03	Fuel Temperature Input Voltage High
174	04	Fuel Temperature Input Voltage Low
611	03	Injector Wiring Shorted to Power Source
611	04	Injector Wiring Shorted to Ground
620	03	Sensor Supply Voltage High
620	04	Sensor Supply Voltage Low
627	01	Injector Supply Voltage Problem
629	12/13	ECM Error
636	02	Cam Position Input Noise
636	08	Cam Position Input Missing
636	10	Cam Position Input Pattern Error
637	02	Cam Position Input Noise
637	08	Cam Position Input Missing
637	07	Crank Position/Cam Position Out of Sync
637	10	Crank Position Input Pattern Error
651	05	Cylinder #1 EUI Circuit Open
651	06	Cylinder #1 EUI Circuit Shorted
652	05	Cylinder #2 EUI Circuit Open
652	06	Cylinder #2 EUI Circuit Shorted
653	06	Cylinder #3 EUI Circuit Open
653	05	Cylinder #3 EUI Circuit Shorted
654	06	Cylinder #4 EUI Circuit Open
654	05	Cylinder #4 EUI Circuit Shorted
655	06	Cylinder #5 EUI Circuit Open
655	05	Cylinder #5 EUI Circuit Shorted
656	05	Cylinder #6 EUI Circuit Open
656	06	Cylinder #6 EUI Circuit Shorted
970	02	Auxiliary Engine Shutdown Switch Signal Invalid
970	31	Auxiliary Engine Shutdown Switch Active
971	31	External Fuel Derate Switch Active
1109	31	Engine Shutdown Warning
1110	31	Engine Shutdown
1569	31	Fuel Derate
2000	13	Security Violation

NOTE: The PowerView diagnostic gauge can have communication problems that result in Error Codes being shown on its LCD display window. The following Error Codes all indicate that there is a Diagnostic Gauge communication error with the ECM. Contact your servicing dealer for help in correcting these codes:

EE – Error XXXXXX – EP
 No Data

ACP – Err XXXXXX - BO
 No Addr No Data

ACP – Err XXXXXX - BR
 BUS – EP No Data

NOTE: Refer to wiring diagnostic earlier in this section as a guide to connections and wires.

6.0 PARTS INFORMATION

6.1 SPARE PARTS

To ensure best operation and efficiency of all engine components, always use genuine Clarke spare parts. Orders should specify:

- Engine Model Number - See Engine General
- Engine Serial Number - Specification
- Part Number(s) Refer to Engine Maintenance Parts List section 6.2 or Parts Illustration (see Page 5).

Contact numbers for spare parts:

- www.clarkefire.com
- Phone USA: (513) 771-2200 Ext. 427 (calling within USA)
- Phone UK: (44) 1236 429946 (calling outside USA)
- Fax USA: (513) 771-5375 (calling within USA)
- Fax UK: (44) 1236 427274 (calling outside USA)
- E-Mail USA: parts@clarkefire.com
- E-Mail UK: dmurray@clarkefire.com

6.2 ENGINE MAINTENANCE PARTS LIST

Refer to Appendix “A” at the end of this manual.

7.0 OWNER ASSISTANCE

Consult Clarke Service Dealer or Factory. Service Dealers can be located by going to our website: www.clarkefire.com.

8.0 WARRANTY

8.1 GENERAL WARRANTY STATEMENT

The satisfactory performance of Clarke engines and the goodwill of owners / operators of Clarke engines are of primary concern to the Engine Manufacturer, the Engine Service Dealer and Clarke. All provide support of these products after final installation of the complete fire pump and sprinkler system. Warranty responsibility involves both Clarke and the John Deere service organizations worldwide.

The Engine Manufacturer (John Deere) provides Warranty for the basic engine components and Clarke provides warranty on the accessories added to meet the NFPA-20 specifications and FM/UL certification requirements.

8.2 CLARKE WARRANTY

All Clarke warranted components have warranty duration of 24 months beginning at the Start-up date of the fire pump system. The warranty coverage includes replacement of the part and reasonable cost of labor for installation. Components failed due to improper engine installation, transportation damage, or misuse is not covered under this warranty.

For additional warranty details, see the specific warranty statement "John Deere New Engine Warranty" on the below. Also contact Clarke direct if you have any questions or require additional information.

Clarke is not responsible for incidental or consequential costs, damage or expenses which the owner may incur as a result of a malfunction or failure covered by this warranty.

8.3 JOHN DEERE WARRANTY

8.3.1 Warranty Duration

Unless otherwise provided in writing, John Deere* makes the following warranty to the first retail purchaser and each subsequent purchaser (if purchase is made prior to expiration of applicable warranty) of each John Deere new off-highway engine marketed as part of a product manufactured by a company other than John Deere or its affiliates:

- 12 months, unlimited hours of use, or
- 24 months and prior to the accumulation of 2000 hours of use;

and on each John Deere engine used in an off-highway repower application:

- 12 months, unlimited hours of use.

Note: In the absence of a functional hourmeter, hours of use will be determined on the basis of 12 hours of use per calendar day.

(*John Deere" means Deere Power Systems Group with respect to users in the United States, John Deere Limited with respect to users in Canada, and Deere & Company or its subsidiary responsible for marketing John Deere equipment in other countries where the user is located)

8.3.2 Warranty Coverage

This warranty applies to the engine and to integral components and accessories sold by John Deere.

All John Deere-warranted parts and components of John Deere engines which, as delivered to the purchaser, are defective in materials and/or workmanship will be repaired or replaced, as John Deere elects, without charge for parts or engine repair labor, including reasonable costs of labor to remove and reinstall non engine parts or components of the equipment in which the engine is installed, and, when required, reasonable costs of labor for engine removal and reinstallation, if such defect appears within the warranty period as measured from the date of delivery to the first retail purchaser, if the delivery is reported to John Deere within 30 days of the delivery.

8.3.3 Emissions System Warranty (Non-Road Diesel)

Refer to the corresponding Engine Manufacturers' Operation and Maintenance manual (applicable only for Emissions Certified Engines).

8.3.4 Obtaining Warranty Service

Warranty service must be requested of the nearest authorized John Deere engine service outlet before the expiration of the warranty. An authorized service outlet is a John Deere engine distributor, a John Deere engine service dealer, or a John Deere equipment dealer selling and servicing equipment with an engine of the type covered by this warranty.

Authorized service outlets will use only new or remanufactured parts or components furnished or approved by John Deere.

Authorized service locations and the name of the John Deere division or subsidiary making this warranty are listed in the Parts and Service Directory for John Deere Engines.

At the time of requesting warranty service, the purchaser must be prepared to present evidence of the date of delivery of the engine.

John Deere reimburses authorized service outlets for limited travel expenses incurred in making warranty service repairs in non-John Deere applications when travel is actually performed. The limit, as of the date

of publication of this statement, is US \$300.00 or equivalent. If distances and travel times are greater than reimbursed by John Deere, the service outlet may charge the purchaser for the difference.

8.3.5 Warranty Exclusions

John Deere's obligations shall not apply to fuel injection pump and nozzles during the pump and nozzle manufacturer's warranty period on the pump and nozzles, components and accessories which are not furnished or installed by John Deere, nor to failures caused by such items. When the pump manufacturer's warranty is less than the engine warranty, John Deere will reimburse pump repair costs for warrantable-type failures during the remainder of the original engine warranty period, when so documented by the pump manufacturer's approved service outlet.

8.3.6 Purchaser's Responsibilities

The cost of normal maintenance and depreciation. Consequences of negligence, misuse, or accident involving the engine, or improper application, installation, or storage of the engine, or improper application, installation, or storage of the engine.

Consequences of service performed by someone other than a party authorized to perform warranty service, if such service, in John Deere's judgment, has adversely affected the performance or reliability of the engine.

Consequences of any modification or alteration of the engine not approved by John Deere, including, but not limited to, tampering with fuel and air delivery systems.

The effects of cooling system neglect as manifested in cylinder liner or block cavitation ("pitting", "erosion", "electrolysis").

Any premium for overtime labor requested by the purchaser.

Costs of transporting the engine or the equipment in which it is installed to and from the location at which the warranty service is performed, if such costs are in excess of the maximum amount payable to the service location were the warranty service performed at the engine's location.

Costs incurred in gaining access to the engine; i.e., overcoming physical barriers such as walls, fences, floors, decks or similar structures impeding access to

the engine, rental of cranes or similar, or construction of ramps or lifts or protective structures for engine removal and reinstallation.

Incidental travel costs including tolls, meals, lodging, and similar.

Service outlet costs incurred in solving or attempting to solve non-warrantable problems.

Services performed by a party other than an authorized John Deere engine service dealer, unless required by law.

Charges by dealers for initial engine start-up and inspection, deemed unnecessary by John Deere when operation and maintenance instructions supplied with the engine are followed.

Costs of interpreting or translating services.

8.3.7 No Representations or Implied Warranty

Where permitted by law, neither John Deere nor any company affiliated with it makes any guaranties, warranties, conditions, representations or promises, express or implied, oral or written, as to the nonoccurrence of any defect or the quality or performance of its engines other than those set forth herein, and DOES NOT MAKE ANY IMPLIED WARRANTY OR CONDITIONS OF MERCHANTABILITY OR FITNESS otherwise provided for in the Uniform Commercial Code or required by any Sale of Goods Act or any other statute. This exclusion includes fundamental terms. In no event will a John Deere engine distributor or engine service dealer, John Deere equipment dealer, or John Deere or any company affiliated with John Deere be liable for incidental or consequential damages or injuries including, but not limited to, loss of profits, loss of crops, rental of substitute equipment or other commercial loss, damage to the equipment in which the engine is installed or for damage suffered by purchaser as a result of fundamental breaches of contract or breach of fundamental terms, unless such damages or injuries are caused by the gross negligence or intentional acts of the foregoing parties.

8.3.8 Remedy Limitation

The remedies set forth in this warranty are the purchaser's exclusive remedies in connection with the performance of, or any breach of guaranty, condition, or warranty in respect of new John Deere engines. In the event the above warranty fails to

correct purchaser's performance problems caused by defects in workmanship and/or materials, purchaser's exclusive remedy shall be limited to payment by John Deere of actual damages in an amount not to exceed the cost of the engine.

8.3.9 No Seller's Warranty

No person or entity, other than John Deere, who sells the engine or product in which the engine has been installed makes any guaranty or warranty of its own on any engine warranted by John Deere unless it delivers to the purchaser a separate written guaranty certificate specifically guaranteeing the engine, in which case John Deere shall have no obligation to the purchaser. Neither original equipment manufacturers, engine or equipment distributors, engine or equipment dealers, nor any other person or entity, has any authority to make any representation or promise on behalf of John Deere or to modify the terms or limitations of this warranty in any way.

8.3.10 Additional Information

For additional information concerning the John Deere New Off-Highway Engine Warranty, see booklet Engine Owner's Warranty – Worldwide.

9.0 INSTALLATION & OPERATION DATA (See Page 5)

10.0 WIRING DIAGRAMS (See Page 5)

11.0 PARTS ILLUSTRATION DRAWING (See Page 5)

12.0 KEYWORD INDEX

Subject	Page
(A)	
Air Filter.....	11, 13, 38, 39, 51, 64, 65, 66
Alternator.....	49, 51, 64, 65, 66
(B)	
Battery Cables.....	15, 16
Battery Recommendations.....	12, 50
Belt Adjustment.....	49
(C)	
Capacities.....	42, 43
Coolant Recommendations.....	11, 12, 13, 16, 42, 43, 48, 51
Cooling System	
Anti-Freeze Solutions.....	43
Cooling System Capacity.....	43
Cooling Water Supply (Loop).....	13, 16, 45
Cooling Water Flow Requirements.....	*
Filling Procedure.....	37, 44
Heat Exchanger.....	6, 44, 46, 44, 45, 46, 47, 48, 51, 64, 65, 66
Inhibitors.....	43, 44
Maintenance.....	12, 14, 29, 30, 31, 35, 51, 53
Water.....	43
Crankcase Ventilation.....	12, 40, 51
(D)	
Diagnostic Trouble Codes.....	20, 52
Dipstick, Oil Level.....	41, 42
Driveshaft alignment.....	13, 14, 15, 16
Driveshaft Maintenance.....	15
(E)	
ECM – Engine Control Module.....	11, 14, 18, 19, 20, 25, 49, 50, 51, 52, 53
Electrical System.....	10, 49
Engine Gauge Panel.....	13, 14, 16, 19, 49, 50
Engine Models.....	7
Engine Out of Fuel.....	36
Engine Protective Systems (overspeed).....	24, 40, 49, 50
Exhaust System.....	13, 38, 40, 41, 51
(F)	
Falk “Steelflex” Coupling.....	13, 16, 18
Fuel Filter.....	7, 12, 13, 30, 31, 32, 33, 34, 35, 36, 37, 51, 64, 65, 66
Fuel Specifications.....	12, 29, 30
Fuel System Operation.....	
Bleeding.....	30, 31, 32
Hand Primer Pump.....	31, 32, 35, 36, 37, 38

Subject	Page
(H)	
Heater, Engine.....	11, 13, 43, 47, 48, 49, 51
(I)	
Installation Data.....	*
Installation Instructions.....	12
(L)	
Lubricating Oil Volume.....	42, 51
Lubricating System.....	41
(M)	
Maintenance Schedule.....	51
Manual Operation.....	16, 17, 18, 19, 20, 42
Model Number Identification.....	6
(N)	
Name Plate (Engine).....	6
(O)	
Oil Filter.....	12, 42, 51, 64, 65
Oil Pressure.....	*
Oil Specifications/Recommendations.....	42
Operation Data.....	*
Out Of Fuel.....	36
Overspeed Reset.....	49, 50
Overspeed Verification.....	50
(P)	
Parts Illustrations.....	*
Parts Information.....	53, 64, 65, 66
Powerview Gauge.....	18, 20, 52, 53
Pump:	
Fuel Injection Pump.....	31, 55
Fuel Lift Pump.....	51
(S)	
Serial Number.....	6, 53
Shutdown Systems.....	19, 20, 24, 25, 45, 49, 50, 53
Speed Adjustment.....	14, 50
Storage.....	12, 30, 55
(T)	
Technical Data.....	*
(W)	
Warranty.....	14, 53, 54
Wiring Diagram:	
DC System.....	*
AC Heater Systems.....	*

* See Page 5



How To Use This Manual

This manual provides detailed instructions on maintenance, lubrication, installation, and parts identification. Use the table of contents below to locate required information.

Table of Contents

Introduction	Page 1
Lube Fittings	Page 1
Limited End Float	Page 1
Lubrication	Pages 1-2
Installation & Alignment Instructions	Pages 2-4
Annual Maintenance, Relube & Disassembly	Page 4
Installation & Alignment Data	Page 5
Parts Identification & Parts Interchangeability	Page 6

CAREFULLY FOLLOW THE INSTRUCTIONS IN THIS MANUAL FOR OPTIMUM PERFORMANCE AND TROUBLE FREE SERVICE.

INTRODUCTION

This manual applies to Sizes 1020T thru 1140T and 20T thru 140T10 Falk Steelflex Tapered Grid Couplings. Unless otherwise stated, information for Sizes 1020T thru 1140T applies to Sizes 20T thru 140T respectively, e.g. 1020T = 20T, 1100T = 100T, etc. These couplings are designed to operate in either the horizontal or vertical position without modification. Beginning in year 1994 through 2003, these couplings were being supplied with one set of inch series fasteners and one set of Metric fasteners. Beginning in year 2004 only Metric fasteners are being supplied. Refer to Page 6 for part interchangeability.

The performance and life of the couplings depend largely upon how you install and service them.

CAUTION: Consult applicable local and national safety codes for proper guarding of rotating members. Observe all safety rules when installing or servicing couplings.

WARNING: Lockout starting switch of prime mover and remove all external loads from drive before installing or servicing couplings.

LUBE FITTINGS

Cover halves have $\frac{1}{8}$ NPT lube holes. Use a standard grease gun and lube fitting as instructed on Page 4.

LIMITED END FLOAT

When electric motors, generators, engines, compressors and other machines are fitted with sleeve or straight roller bearings, limited axial end float kits are recommended for protecting the bearings. Falk Steelflex couplings are easily modified to limit end float; refer to Manual 428-820 for instructions.

LUBRICATION

Adequate lubrication is essential for satisfactory operation. Page 2 provides a list of typical lubricants and specifications for general purpose and long term greases. Because of its

TYPE T10 STEELFLEX COUPLING

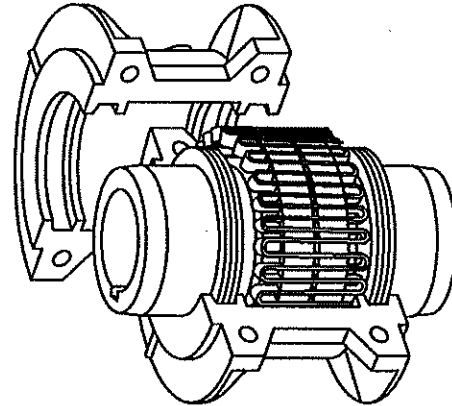

superior lubricating characteristics and low centrifuge properties, Falk Long Term Grease (LTG) is highly recommended. Sizes 1020T to 1090T10 are furnished with a pre-measured amount of grease for each coupling. The grease can be ordered for larger size couplings.

The use of general purpose grease requires re-lubrication of the coupling at least annually.

Long Term Grease (LTG)

The high centrifugal forces encountered in couplings separate the base oil and thickener of general purpose greases. Heavy thickener, which has no lubrication qualities, accumulates in the grid-groove area of Steelflex couplings resulting in premature hub or grid failure unless periodic lubrication cycles are maintained.

Falk Long Term Grease (LTG) was developed specifically for couplings. It resists separation of the oil and thickener. The consistency of Falk LTG changes with operating conditions. As manufactured it is an NLGI #1/2 grade. Working of the lubricant under actual service conditions causes it to become semifluid while the grease near the seals will set to a heavier grade, helping to prevent leakage.

LTG is highly resistant to separation, easily out performing all other lubricants tested. The resistance to separation allows the lubricant to be used for relatively long periods of time.

Steelflex couplings initially lubricated with LTG will not require re-lubrication until the connected equipment is stopped for servicing. If a coupling leaks grease, is exposed to extreme temperatures, excessive moisture, or experiences frequent reversals, more frequent lubrication may be required.

Although LTG grease is compatible with most other coupling greases, the mixing of greases may dilute the benefits of LTG.

USDA Approval

LTG has the United States Department of Agriculture Food Safety & Inspection Service approval for applications where there is no possibility of contact with edible products. (H-2 ratings).

CAUTION: Do not use LTG in bearings.



Specifications — Falk LTG

The values shown are typical and slight variations are permissible.

AMBIENT TEMPERATURE RANGE — -20°F (-29°C) to 250°F (121°C). Min. Pump = 20° F (-7° C).

MINIMUM BASE OIL VISCOSITY — 3300SSU (715cST) @ 100°F (38°C).

THICKENER — Lithium & soap/polymer.

CENTRIFUGE SEPARATION CHARACTERISTICS — ASTM #D4425 (Centrifuge Test) — K36 = 2/24 max., very high resistance to centrifuging.

NLGI GRADE (ASTM D-217) — 1/2

CONSISTENCY (ASTM D-217) — 60 stroke worked penetration value in the range of 315 to 360 measured at 77°F (25°C)

MINIMUM DROPPING POINT — 350°F (177°C) minimum

MINIMUM TIMKEN O.K. LOAD — 40 lbs.

ADDITIVES — Rust and oxidation inhibitors that do not corrode steel or swell or deteriorate synthetic seals.

Packaging

14 oz. (0,4 kg) CARTRIDGES — Individual or case lots of 10 or 30.

35 lb. (16 kg)PAIL, 120 lb. (54 kg) KEG & 400 lb. (181 kg) DRUMS..

General Purpose Grease

Annual Lubrication — The following specifications and lubricants for general purpose grease apply to Falk Steelflex couplings that are lubricated annually and operate within ambient temperatures of 0°F to 150°F (-18°C to 66°C). For temperatures beyond this range (see Table 1), consult the Factory.

If a coupling leaks grease, is exposed to extreme temperatures, excessive moisture or experiences frequent reversals, more frequent lubrication may be required.

Specifications — General Purpose Coupling Lubricants

The values shown are typical and slight variations are permissible.

DROPPING POINT — 300°F (149°C) or higher.

CONSISTENCY — NLGI No. 2 with 60 stroke worked penetration value in the range of 250 to 300.

SEPARATION AND RESISTANCE — Low oil separation rate and high resistance to separation from centrifuging.

LIQUID CONSTITUENT — Possess good lubricating properties equivalent to a high quality, well refined petroleum oil.

INACTIVE — Must not corrode steel or cause swelling or deterioration of synthetic seals.

CLEAN — Free from foreign inclusions.

General Purpose Greases Meeting Rexnord Specifications

Lubricants listed below are typical products only and should not be construed as exclusive recommendations.

TABLE 1 — General Purpose Greases *

Ambient Temperature Range	0°F to 150°F (-18°C to 66°C)	-30°F to 100°F (-34°C to 38°C)
Manufacturer	Lubricant †	Lubricant †
Amoco Oil Co.	Amolith Grease #2	Amolith Grease #2
BP Oil Co.	Energrease LS-EP2	Energrease LS-EP1
Chevron U.S.A. Inc.	Dura-Lith EP2	Dura-Lith EP1
Citgo Petroleum Corp.	Premium Lithium Grease EP2	Premium Lithium Grease EP1
Conoco Inc.	EP Conolith Grease #2	EP Conolith Grease #2
Exxon Company USA	Unirex EP2	Unirex EP2
E.F. Houghton & Co.	Cosmolube 2	Cosmolube 1
Imperial Oil Ltd.	Unirex EP2	Unirex EP2
Kendall Refining Co.	Lithium Grease L421	Lithium Grease L421
Keystone Div. (Pennwalt)	81 EP-2	81 EP-1
Lyondell Petrochemical (ARCO)	Litholine H EP 2 Grease	Litholine H EP 2 Grease
Mobil Oil Corp.	Mobilux EP111	Mobilith AW1
Petro-Canada Products	Multipurpose EP2	Multipurpose EP1
Phillips 66 Co.	Philube Blue EP	Philube Blue EP
Shell Oil Co.	Alvania Grease 2	Alvania Grease 2
Shell Canada Ltd.	Alvania Grease 2	Alvania Grease 2
Sun Oil Co.	Ultra Prestige 2EP	Ultra Prestige 2EP
Texaco Lubricants	Starplex HD2	Multifak EP2
Unocal 76 (East & West)	Unoba EP2	Unoba EP2
Valvoline Oil Co.	Multilube Lithium EP Grease	...

* Grease application or re-lubrication should be done at temperatures above 20°F (-7°C). If grease must be applied below 20°F (-7°C), consult the Factory.

† Lubricants listed may not be suitable for use in the food processing industry; check with lube manufacturer for approved lubricants.

INSTALLATION OF TYPE T10 STEELFLEX TAPERED GRID COUPLINGS

Installation

Only standard mechanics tools, wrenches, a straight edge and feeler gauges are required to install Falk Steelflex couplings. Coupling Sizes 1020T thru 1090T are generally furnished for CLEARANCE FIT with setscrew over the keyway. Sizes 1100T and larger are furnished for an INTERFERENCE FIT without a setscrew.

CLEARANCE FIT HUBS — Clean all parts using a non-flammable solvent. Check hubs, shafts and keyways for burrs. Do not heat clearance fit hubs. Install keys, mount hubs with flange face flush with shaft ends or as otherwise specified and tighten setscrews.

INTERFERENCE FIT HUBS — Furnished without setscrews. Heat hubs to a maximum of 275°F (135°C) using an oven, torch, induction heater or an oil bath. To prevent seal damage, DO NOT heat hubs beyond a maximum temperature of 400°F (205°C).

When an oxy-acetylene or blow torch is used, use an excess acetylene mixture. Mark hubs near the center of their length in several places on hub body with a temperature sensitive crayon, 275°F (135°C) melt temperature. Direct flame towards hub bore using constant motion to avoid overheating an area.

WARNING: If an oil bath is used, the oil must have a flash point of 350°F (177°C) or higher. Do not rest hubs on the bottom of the container. Do not use an open flame in a combustible atmosphere or near combustible materials.

Heat hubs as instructed above. Mount hubs as quickly as possible with hub face flush with shaft end. Allow hubs to cool before proceeding. Insert setscrews (if required) and tighten.

Maximize Performance And Life

The performance and life of couplings depend largely upon how you install and maintain them. Before installing couplings, make certain that foundations of equipment to be connected meet manufacturers' requirements. Check for soft foot. The use of stainless steel shims is recommended. Measuring misalignment and positioning equipment within alignment tolerances is simplified with an alignment computer. These calculations can also be done graphically or mathematically.

Alignment is shown using spacer bar and straight edge. This practice has proven to be adequate for many industrial applications. However, for superior final alignment, the use of dial indicators (see Manual 458-834 for instructions), lasers, alignment computers or graphical analysis is recommended.

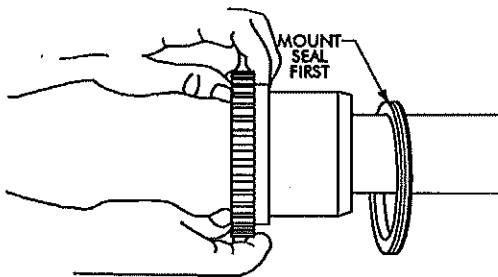

1— Mount Seals And Hubs

Lock out starting switch of prime mover. Clean all metal parts using a non-flammable solvent. Lightly coat seals with grease and place on shafts BEFORE mounting hubs. Heat interference fit hubs as previously instructed. Seal keyways to prevent leakage. Mount hubs on their respective shafts so the hub face is flush with the end of its shaft unless otherwise indicated. Tighten setscrews when furnished.

2 — Gap and Angular Alignment

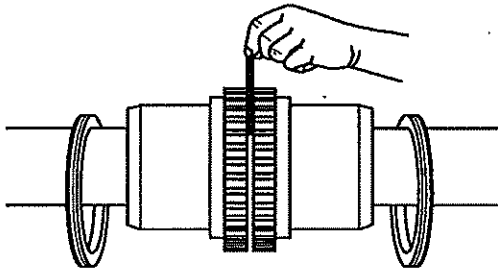

Use a spacer bar equal in thickness to the gap specified in Table 2, Page 5. Insert bar as shown below left, to same depth at 90° intervals and measure clearance between bar and hub face with feelers. The difference in minimum and maximum measurements must not exceed the ANGULAR installation limits specified in Table 2.

3 — Offset Alignment

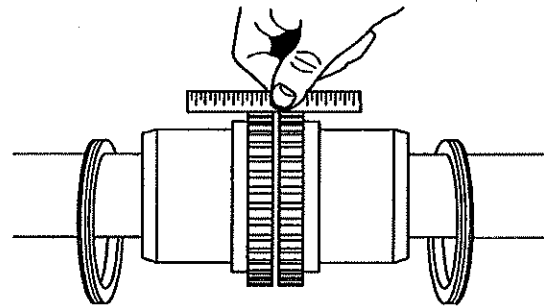

Align so that a straight edge rests squarely (or within the limits specified in Table 2) on both hubs as shown above and also at 90° intervals. Check with feelers. The clearance must not exceed the PARALLEL OFFSET installation limits specified in Table 2. Tighten all foundation bolts and repeat Steps 2 and 3. Realign coupling if necessary.

4 — Insert Grid

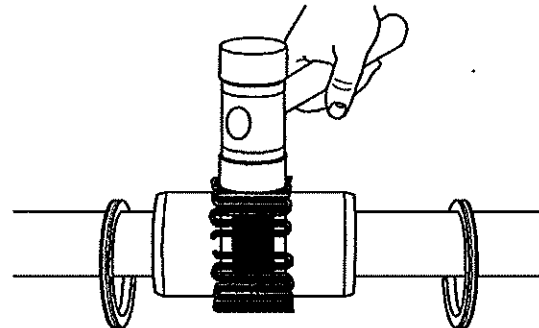

Pack gap and grooves with specified lubricant before inserting grid. When grids are furnished in two or more segments, install them so that all cut ends extend in the same direction (as detailed in the exploded view picture above); this will assure correct grid contact with non-rotating pin in cover halves. Spread the grid slightly to pass over the coupling teeth and seat with a soft mallet.

5 — Pack With Grease And Assemble Covers

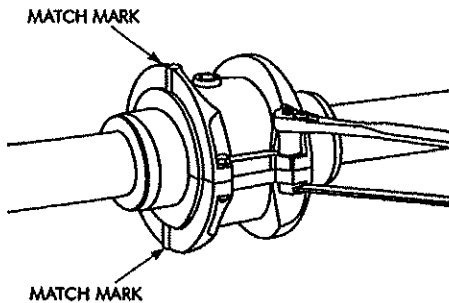
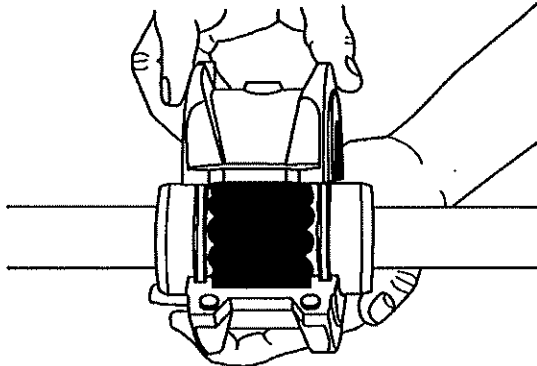

Pack the spaces between and around the grid with as much lubricant as possible and wipe off excess flush with top of grid. Position seals on hubs to line up with grooves in cover. Position gaskets on flange of lower cover half and assemble covers so that the match marks are on the same side (see above). If shafts are not level (horizontal) or coupling is to be used vertically, assemble cover halves with the lug and match

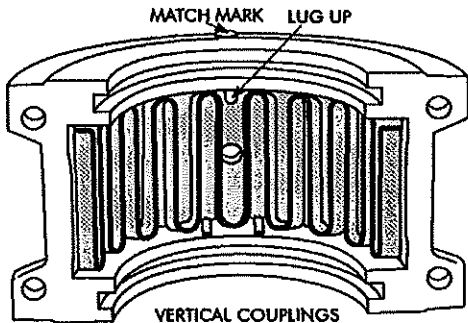

mark UP or on the high side. Push gaskets in until they stop against the seals and secure cover halves with fasteners, tighten to torque specified in Table 2. Make sure gaskets stay in position during tightening of fasteners. **CAUTION:** Make certain lube plugs are installed before operating.

ANNUAL MAINTENANCE

For extreme or unusual operating conditions, check coupling more frequently.

1. Check alignment per steps on Page 3. If the maximum operating misalignment limits are exceeded, realign the coupling to the recommended installation limits. See Table 2 for installation and operating alignment limits.
2. Check tightening torques of all fasteners.
3. Inspect seal ring and gasket to determine if replacement is required. If leaking grease, replace.
4. When connected equipment is serviced, disassemble the coupling and inspect for wear. Replace worn parts. Clean grease from coupling and repack with new grease. Install coupling using new gasket as instructed in this manual.

Periodic Lubrication

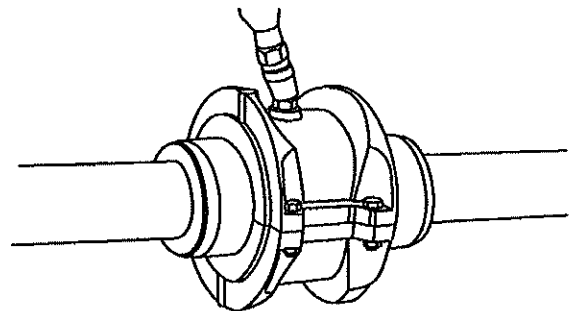

The required frequency of lubrication is directly related to the type of lubricant chosen, and the operating conditions. Steelflex couplings lubricated with common industrial lubricants, such as those shown in Table 1, should be relubed annually. The use of Falk Long Term Grease (LTG) will allow relube intervals to be extended to beyond five years. When relubing, remove both lube plugs and insert lube fitting. Fill with recommended lubricant until an excess appears at the opposite hole. **CAUTION:** Make certain all plugs have been inserted after lubricating.

Coupling Disassembly And Grid Removal

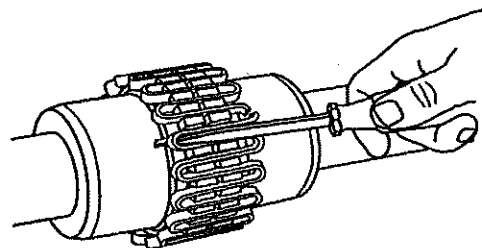

Whenever it is necessary to disconnect the coupling, remove the cover halves and grid. A round rod or screwdriver that will conveniently fit into the open loop ends of the grid is required. Begin at the open end of the grid section and insert the rod or screwdriver into the loop ends. Use the teeth adjacent to each loop as a fulcrum and pry the grid out radially in even, gradual stages, proceeding alternately from side to side.

TYPE T COUPLING INSTALLATION & ALIGNMENT DATA

Maximum life and minimum maintenance for the coupling and connected machinery will result if couplings are accurately aligned. Coupling life expectancy between initial alignment and maximum operating limits is a function of load, speed and lubrication. Maximum operating values listed in Table 2 are based on cataloged allowable rpm.

Values listed are based upon the use of the gaps listed, standard coupling components, standard assemblies and cataloged allowable speeds.

Values may be combined for an installation or operating condition.

Example: 1060T max. operating misalignment is .016" parallel plus .018" angular.

NOTE: For applications requiring greater misalignment, refer application details to the Factory.

Angular misalignment is dimension X minus Y as illustrated below.

Parallel misalignment is distance P between the hub center lines as illustrated below.

End float (with zero angular and parallel misalignment) is the axial movement of the hubs(s) within the cover(s) measured from "O" gap.

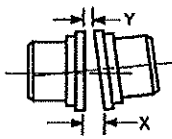
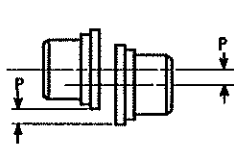
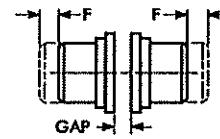
ANGULAR MISALIGNMENT

PARALLEL OFFSET MISALIGNMENT

END FLOAT

TABLE 2 — Misalignment & End Float

SIZE	Installation Limits						Operating Limits						Cover Fastener Tightening Torque Values Inch or Metric Series Fasteners		Allow Speed (rpm)	Lube Wt	
	Parallel Offset-P		Angular (x-y)		Hub Gap ± 10%		Parallel Offset-P		Angular (x-y)		End Float Physical Limit (Min) 2 x F						
	Max Inch	Max mm	Max Inch	Max mm	Inch	mm	Max Inch	Max mm	Max Inch	Max mm	Inch	mm	(lb-in)	(Nm)	lb	kg	
1020T	.006	0.15	.003	0.08	.125	3	.012	0.30	.010	0.25	.210	5.33	100	11.3	4500	.06	0.03
1030T	.006	0.15	.003	0.08	.125	3	.012	0.30	.012	0.30	.198	5.03	100	11.3	4500	.09	0.04
1040T	.006	0.15	.003	0.08	.125	3	.012	0.30	.013	0.33	.211	5.36	100	11.3	4500	.12	0.05
1050T	.008	0.20	.004	0.10	.125	3	.016	0.41	.016	0.41	.212	5.38	200	22.6	4500	.15	0.07
1060T	.008	0.20	.005	0.13	.125	3	.016	0.41	.018	0.46	.258	6.55	200	22.6	4350	.19	0.09
1070T	.008	0.20	.005	0.13	.125	3	.016	0.41	.020	0.51	.259	6.58	200	22.6	4125	.25	0.11
1080T	.008	0.20	.006	0.15	.125	3	.016	0.41	.024	0.61	.288	7.32	200	22.6	3600	.38	0.17
1090T	.008	0.20	.007	0.18	.125	3	.016	0.41	.028	0.71	.286	7.26	200	22.6	3600	.56	0.25
1100T	.010	0.25	.008	0.20	.188	5	.020	0.51	.033	0.84	.429	10.90	312	35	2440	.94	0.43
1110T	.010	0.25	.009	0.23	.188	5	.020	0.51	.036	0.91	.429	10.90	312	35	2250	1.1	0.51
1120T	.011	0.28	.010	0.25	.250	6	.022	0.56	.040	1.02	.556	14.12	650	73	2025	1.6	0.74
1130T	.011	0.28	.012	0.30	.250	6	.022	0.56	.047	1.19	.551	14.00	650	73	1800	2.0	0.91
1140T	.011	0.28	.013	0.33	.250	6	.022	0.56	.053	1.35	.571	14.50	650	73	1650	2.5	1.14

TABLE 3 — Coupling Cover Fastener Identification

SIZE	Inch Series Fasteners				METRIC FASTENERS	
	Old Style		New Style			
1020-1070T10		SAE Grade 8 *		SAE Grade 8		Property Class 10.9
1080-1090T10		SAE Grade 8		SAE Grade 8		Property Class 10.9
1100-1140T10		SAE Grade 5		SAE Grade 5		Property Class 8.8

* Older style covers, Sizes 1020T10 thru 1070T10 must utilize socket head cap screws and locknuts held by the cover.



PARTS IDENTIFICATION

All coupling parts have identifying part numbers as shown below. Parts 3 and 4 (Hubs and Grids), are the same for both Type T10 and T20 couplings. All other coupling parts are unique to Type T10. When ordering parts, always SPECIFY SIZE and TYPE shown on the COVER.

PARTS INTERCHANGEABILITY

Parts are interchangeable between Sizes 20T and 1020T, 30T and 1030T, etc. except as noted.

GRIDS — Size 1020T thru 1140T Steelflex couplings use blue or non-painted grids. Older models, 20T thru 140T, use orange grids.

CAUTION: Blue or non-painted grids may be used in all applications, but DO NOT substitute orange grids for blue or nonpainted.

COVERS — **CAUTION:** DO NOT mix cover halves of different designs. Sizes 1020T thru 1070T10 covers have been manufactured in several different two-rib designs and 80T thru 140T covers have been manufactured with two and three ribs.

HARDWARE — Older style covers, Sizes 1020T10 thru 1070T10, utilized socket head cap screws with captured locknuts. The new style covers use hex head cap screws (either inch or metric from year 1994 through 2003 and only Metric beginning in 2004). Specify the style cover when ordering replacement parts.

PART NUMBER LOCATION

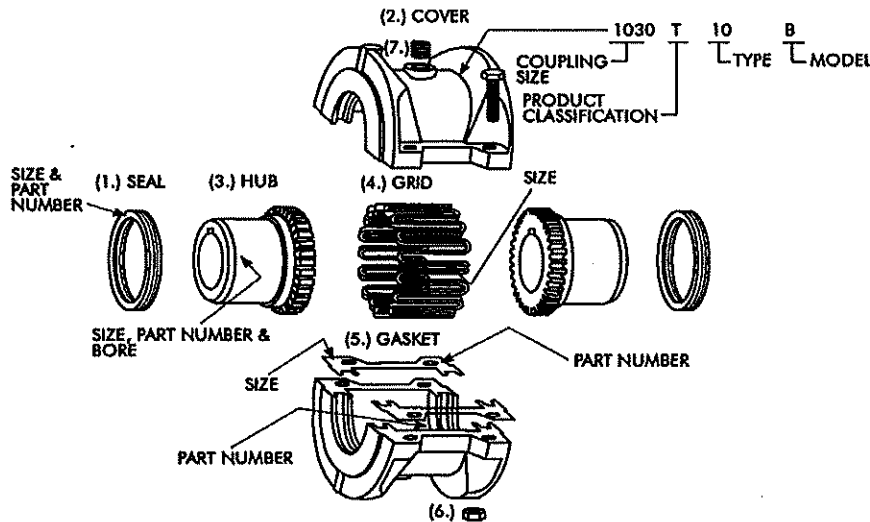

PART DESCRIPTION

1. Seal (T10)
2. Cover (T10)
3. Hub (Specify bore and keyway)
4. Grid
5. Gasket (T10)
6. Metric Fasteners (T10).
7. Lube Plug

ORDER INFORMATION

1. Identify part(s) required by name above.
2. Furnish the following information.

EXAMPLE:

Coupling Size: 1030
 Coupling Type: T10
 Model: B
 Bore: 1.375
 Keyway: .375 x .187

3. Contact your Rexnord Distributor or Rexnord for price and availability.

JU4/JU6H MODELS

Clarke Engine Models	JU4H-UFADW8, JU4H-UFADY8, JU4H-UFAD98, JU4H-UFAD4G, JU4H-UFAD5G, JU4H-UFAD58, JU4H-UFADP0, JU4H-UFADR0, JU4H-UFADJG*	JU6H-UFADN0, JU6H-UFAD88, JU6H-UFAD58, JU6H-UFADNG, JU6H-UFADP8, JU6H-UFADM8, JU6H-UFADMG, JU6H-UFADK0*	JU6H-UFAD98, JU6H-UFADR8, JU6H-UFADS8, JU6H- UFADW8, JU6H-UFADX8	JU6H-UFADT0*, JU6H-UFADP0*, JU6H-UFADR0*, JU6H-UFADQ0*
	* Includes -D, -S, and -DS models			
Part Description	Part Number (standard items only, optional items not shown)			
Oil Filter	C04521			
Fuel Filter (Primary)	C02775			
Fuel Filter (Secondary)	C02776			
Air Filter	C03396	C03244		
Alternator	C071363 (12V) or C071365 (24V)			
Fuel Pump, High Pressure	C02778	C02777	C02778	
Heat Exchanger	C051386			
Starter Motor (12V)	RIGHT SIDE- C071588 and LEFT SIDE- C071587	RIGHT SIDE – C071946 and LEFT SIDE – C071944 or RIGHT SIDE - C071071 and LEFT SIDE - C071072		
Starter Motor (24V)	RIGHT SIDE- C071073 and LEFT SIDE- C071074			
Engine Control Module	C071948			C071947
Turbocharger	C061521	C061522 (12V) C061523 (24V)	C061524 (12V) C061525 (24V)	
Thermostat	C071950	C071951 (1) and C071952 (2)		
Nozzle, Injector	C02779	C02780		

JW6H MODELS

Clarke Engine Models	JW6H-UFAD80, JW6H-UFADB0, JW6H-UFADF0, JW6H-UFADJ0, JW6H-UFAD70, JW6H-UFAD80	JW6H-UFADD0*
	* Includes -D, -S, and -DS models	
Part Description	Part Number (standard items only, optional items not shown)	
Oil Filter	C04593	
Fuel Filter (Primary)	C02773 (INCLUDES PRIMARY AND SECONDARY)	
Fuel Filter (Secondary)		
Air Filter	C03244	
Alternator	C071363 (12V) or C071365 (24V)	
Fuel Pump, High Pressure	C02774	
Heat Exchanger	C051387 R.B	
Starter Motor (12V)	C071944 or C071072	
Starter Motor (24V)	C071937 or C071074	
Engine Control Module	C071942	
Turbocharger	C061518	C061519 (12V) C061520 (24V)
Thermostat	C072147 (2)	
Nozzle, Injector	C02772	

JX6H MODELS

Clarke Engine Models	JX6H-UFAD88, JX6H-UFADP0, JX6H-UFADNO, JX6H-UFAD60, JX6H-UFADF0, JX6H-UFADK0*
	* Includes -D, -S, and -DS models
Part Description	Part Number (standard items only, optional items not shown)
Oil Filter	C04592
Fuel Filter (Primary)	C02770
Air Filter	C03595
Alternator (24V)	C071365
Heat Exchanger	C051433
Starter Motor (24V)	C071937 OR C071938
Engine Control Module	C071939
Turbocharger	C061517
Thermostat	C071940 (1) C071941 (2)
Nozzle, Injector	C02771

APPENDIX



// Engine Readiness Test Procedures

	HEP – HOLLAND ENERGY PARK	Revision: C
	MONTHLY ELEC.& EMER. FIRE PUMP TEST HBPW ELECTRIC PRODUCTION DEPARTMENT STANDARD OPERATING PROCEDURE	File: EP-1061

Procedure Title:

HEP-SOP-GHF-EP-1061 Monthly Electric and Emergency Fire Pump Test

Revision	Revised By	Date	Comments
A	Terry Kroll	9/12/17	Created by Terry Kroll and Reviewed by M. Richey
B	Terry Kroll	9/28/17	Reviewed by M. Richey
C	M. Richey	11/7/17	Updated with warning about not doing test with U10 and 11 in start-up mode.
D			
E			
F			
G			

	HEP – HOLLAND ENERGY PARK	Revision: C
	MONTHLY ELEC.& EMER. FIRE PUMP TEST HBPW ELECTRIC PRODUCTION DEPARTMENT STANDARD OPERATING PROCEDURE	File: EP-1061

Introduction

This is the test procedure for the Electric and Emergency Diesel Fire Pumps. The Electric Fire Pump needs to be test started and run for 15 minutes every month and the Emergency Diesel Fire Pump needs to be test started and run for 30 minutes every month.

Procedure

WARNING: Do not start or operate the engine if Unit 10 or 11 are in startup mode. Confirm with the Control Room to verify, and have operator log this confirmation in the ops log.

1. Verify that the Jockey Fire Pump has been cycling properly. Run a trend on the pump motor. Should only be turning on once or twice a day to maintain system pressure. The Jockey pump starts at \approx 153 PSI and shuts off at \approx 167 PSI.
2. Bypass the fire protection system so that the fire alarms do not go off through the plant. Take the Speaker Bypass, the Strobe Bypass and the AHU (Air Handling Unit) Bypass to bypass.
3. Take the Jockey Pump control switch from auto to off. This will prevent the Jockey Pump from starting on low pressure.
4. Place a bucket under drain valve AA093 below the Emergency Diesel Control Panel and remove the plug from the line.
5. Slowly crack open valve AA093 and watch pressure bleed off. At \approx 142PSI the Electric Fire Pump will start and bring Fire System pressure to 162PSI. Close valve AA093 and replace the plug. Perform pump checks on the Electric Fire Pump and let run for 15 minutes.
6. Give the Electric Fire Pump a stop after 15 minutes. When the pump has stopped open up the local disconnect on the Electric Fire Pump control panel. This is to prevent the Electric Fire Pump from starting due to low pressure.
7. Place the bucket below valve AA089 located beneath the Electric Fire Pump Control Panel and remove the plug.
8. Check the Diesel Fire Pump oil, coolant and fuel levels. If all are good slowly crack open valve AA089 and bleed pressure off of the system. At \approx 121PSI the Emergency Diesel Fire Pump will start and bring Fire System Pressure up to 155 PSI. Close valve AA089 and replace plug. While the pump is running water will trickle out of the relief valve line and into the drain outside of the building. Perform checks on the diesel and pump. Normal reading are around:

RPM: 1785 Oil Pressure: 53PSI Coolant Temp: 183F HLS: 7
Battery: 12.7V 0.3Amps Alternator: 14.5V 3.5Amps

	HEP – HOLLAND ENERGY PARK	Revision: C
	MONTHLY ELEC.& EMER. FIRE PUMP TEST HBPW ELECTRIC PRODUCTION DEPARTMENT STANDARD OPERATING PROCEDURE	File: EP-1061

9. Run the Diesel Fire Pump for **30 minutes** then give it a stop.
10. Ensure that the Emergency Diesel Fire Pump Controller has control power and is in auto.
11. Take the Jockey Pump control switch to auto. It will kick on for a second and then turn back off.
12. Close the Electric Fire Pump local disconnect and ensure that the pump is in auto and has control power.
13. Reset The Fire Alarm Panel. Make sure that the trouble alarm has cleared then reset the Speaker Bypass, The Strobe Bypass and The AHU Bypass. Hit reset to clear the trouble lights.
14. Record in Operations Log, complete this form and put in the Operations Supervisors mail box.

Operator _____ Date: _____

PM work order # _____ input operator name and any other comments as needed along with Completing the Work order.