

**No. 1 and No. 3 Biofilter  
Air Emissions Test Report  
at  
Decorative Panels International, Inc.  
Alpena, Michigan**

**Renewable Operating Permit MI-ROP-B1476-2009a  
SRN: B1476**

Prepared for  
**Decorative Panels International, Inc.  
416 Ford Avenue  
Alpena, Michigan**

Bureau Veritas Project No. 11015-000211.00  
November 16, 2015



**BUREAU  
VERITAS**

***Move Forward with Confidence***

Bureau Veritas North America, Inc.  
22345 Roethel Drive  
Novi, Michigan 48375  
248.344.2661  
[www.us.bureauveritasHSE.com](http://www.us.bureauveritasHSE.com)



MICHIGAN DEPARTMENT OF ENVIRONMENTAL QUALITY  
AIR QUALITY DIVISION

**RENEWABLE OPERATING PERMIT  
REPORT CERTIFICATION**

Authorized by 1994 P.A. 451, as amended. Failure to provide this information may result in civil and/or criminal penalties.

Reports submitted pursuant to R 336.1213 (Rule 213), subrules (3)(c) and/or (4)(c), of Michigan's Renewable Operating (RO) Permit program must be certified by a responsible official. Additional information regarding the reports and documentation listed below must be kept on file for at least 5 years, as described in General Condition No. 22 in the RO Permit and be made available to the Department of Environmental Quality, Air Quality Division upon request.

Source Name Decorative Panels International County Alpena

Source Address 416 Ford Avenue City Alpena

AQD Source ID (SRN) B1476 RO Permit No. MI-ROP-B1476-2009a RO Permit Section No. D

Please check the appropriate box(es):

**Annual Compliance Certification (General Condition No. 28 and No. 29 of the RO Permit)**

Reporting period (provide inclusive dates): From \_\_\_\_\_ To \_\_\_\_\_

1. During the entire reporting period, this source was in compliance with ALL terms and conditions contained in the RO Permit, each term and condition of which is identified and included by this reference. The method(s) used to determine compliance is/are the method(s) specified in the RO Permit.

2. During the entire reporting period this source was in compliance with all terms and conditions contained in the RO Permit, each term and condition of which is identified and included by this reference, EXCEPT for the deviations identified on the enclosed deviation report(s). The method used to determine compliance for each term and condition is the method specified in the RO Permit, unless otherwise indicated and described on the enclosed deviation report(s).

**Semi-Annual (or More Frequent) Report Certification (General Condition No. 23 of the RO Permit)**

Reporting period (provide inclusive dates): From \_\_\_\_\_ To \_\_\_\_\_

1. During the entire reporting period, ALL monitoring and associated recordkeeping requirements in the RO Permit were met and no deviations from these requirements or any other terms or conditions occurred.

2. During the entire reporting period, all monitoring and associated recordkeeping requirements in the RO Permit were met and no deviations from these requirements or any other terms or conditions occurred, EXCEPT for the deviations identified on the enclosed deviation report(s).

**Other Report Certification**

Reporting period (provide inclusive dates): From na To na

Additional monitoring reports or other applicable documents required by the RO Permit are attached as described:  
Emissions test report to evaluate compliance of the No. 1 and 3 Biofilters.

This form shall certify that the testing was conducted in accordance with the  
approved test plan and that the facility operating conditions were in compliance with  
permit requirements.

I certify that, based on information and belief formed after reasonable inquiry, the statements and information in this report and the supporting enclosures are true, accurate and complete, and that any observed, documented or known instances of noncompliance have been reported as deviations, including situations where a different or no monitoring method is specified by the RO Permit.

Timothy P. Clark President 419-720-0957  
Name of Responsible Official (print or type) Title Phone Number

[Signature] 11/6/15  
Signature of Responsible Official Date



## *Executive Summary*

---

# Executive Summary

Decorative Panels International, Inc. retained Bureau Veritas North America, Inc. to test air emissions from the No. 1 Biofilter and No. 3 Biofilter sources at their hardboard manufacturing facility in Alpena, Michigan. The No. 1 Biofilter controls emissions from the No. 1 Board Press, and cooler (EUPRESS2S). The No. 3 Biofilter controls emissions from the No. 3 Board Press and cooler (EU3-PRESS-AREA). Both sources are grouped in the permit within the FGPRESES and FGMACTDDDD flexible groups.

The objective of the testing was to evaluate compliance of the No. 1 Biofilter and No. 3 Biofilter sources with emission limits and requirements in:

- Michigan Department of Environmental Quality (MDEQ) Renewable Operating Permit (ROP) MI-ROP-B1476-2009a (currently being renewed) for the FGMACTDDDD sources, and
- 40 CFR 63, Subpart DDDD, “National Emission Standards for Hazardous Air Pollutants: Plywood and Composite Wood Products.”

Bureau Veritas measured total hydrocarbons (THC), methanol, and formaldehyde at the inlet and outlet of the No. 1 Biofilter and No. 3 Biofilter control devices.

Three 60-minute compliance test runs were performed at each source under normal operating conditions following United States Environmental Protection Agency (USEPA) Methods 1 through 4, 25A, and 320.

Detailed results are presented in Tables 1 through 2 after the Tables Tab of this report. The following table summarizes the results of the testing conducted on September 17 and 18, 2015.



*Executive Summary*

**No. 1 Biofilter Formaldehyde, Methanol, and THC Results**

Parameter	Units	Run 1	Run 2	Run 3	Average
Formaldehyde inlet concentration	ppmvd	34.3	28.9	34.5	<b>32.5</b>
Formaldehyde inlet emission rate	lb/hr	8.3	7.0	8.3	<b>7.8</b>
Formaldehyde outlet concentration	ppmvd	1.1	1.0	1.1	<b>1.1</b>
Formaldehyde outlet emission rate	lb/hr	0.3	0.3	0.3	<b>0.3</b>
Formaldehyde removal efficiency	%	96.4	95.8	96.3	<b>96.2</b>
Methanol inlet concentration	ppmvd	44.2	36.5	45.6	<b>42.1</b>
Methanol inlet emission rate	lb/hr	11.4	9.4	11.7	<b>10.8</b>
Methanol outlet concentration	ppmvd	10	6.3	8.6	<b>8.3</b>
Methanol outlet emission rate	lb/hr	3.0	1.9	2.5	<b>2.5</b>
Methanol removal efficiency	%	73.9	79.7	78.2	<b>77.3</b>
THC inlet concentration as carbon	ppmvd	384	286	354	<b>341</b>
THC inlet emission rate as carbon	lb/hr	37.2	27.6	34.0	<b>32.9</b>
THC outlet concentration as carbon	ppmvd	48.3	38.7	43.6	<b>43.5</b>
THC outlet emission rate as carbon	lb/hr	5.4	4.4	4.8	<b>4.9</b>
THC removal efficiency	%	85.6	84.2	85.8	<b>80.7</b>

Note: The average biofilter bed temperature during the three test runs was 79°F.

The results of the September 17, 2015 emissions testing established the following:

- The No. 1 Biofilter source complies with the formaldehyde destruction efficiency limit of 90% or greater at a biofilter bed temperature within the previously established compliance range of 73 to 87°F.



*Executive Summary*

**No. 3 Biofilter Formaldehyde, Methanol, and THC Results**

Parameter	Units	Run 1	Run 2	Run 3	Average
Formaldehyde inlet concentration	ppmvd	15.5	14.5	15.5	<b>15.2</b>
Formaldehyde inlet emission rate	lb/hr	2.9	2.8	3.0	<b>2.9</b>
Formaldehyde outlet concentration	ppmvd	0.8	0.9	0.5	<b>0.7</b>
Formaldehyde outlet emission rate	lb/hr	0.2	0.2	0.1	<b>0.2</b>
Formaldehyde removal efficiency	%	93.3	93.2	95.9	<b>94.1</b>
Methanol inlet concentration	ppmvd	22.3	23.9	24.2	<b>23.5</b>
Methanol inlet emission rate	lb/hr	4.4	4.9	5.0	<b>4.8</b>
Methanol outlet concentration	ppmvd	5.6	6.2	4.5	<b>5.4</b>
Methanol outlet concentration	lb/hr	1.4	1.5	1.1	<b>1.3</b>
Methanol removal efficiency	%	68.9	69.9	77.7	<b>72.2</b>
THC inlet concentration as carbon	ppmvd	228	242	256	<b>242</b>
THC inlet emission rate as carbon	lb/hr	17	19	20	<b>18.4</b>
THC outlet concentration as carbon	ppmvd	44.6	44.3	31.9	<b>40.2</b>
THC outlet emission rate as carbon	lb/hr	4.1	4.0	3.0	<b>3.7</b>
THC removal efficiency as carbon	%	76.0	78.7	84.9	<b>79.9</b>

Note: The average biofilter bed temperature during the three test runs was 91°F.

The results of the September 18, 2015 emissions testing established the following:

- The No. 3 Biofilter source complies with the formaldehyde destruction efficiency limit of (1) 90% or greater and (2) formaldehyde concentration limit of <1 part per million by volume, dry (ppmvd) when a formaldehyde concentration greater than 10 ppmvd is entering the control devices at a biofilter bed temperature within the compliance range of 73 to 92°F. The minimum biofilter bed temperature limit was established during a previous performance test; the maximum biofilter bed temperature of 92°F was established during Run 2 of the testing.



---

# 1.0 Introduction

## 1.1 Summary of Test Program

Decorative Panels International, Inc. retained Bureau Veritas North America, Inc. to test air emissions from the No. 1 Biofilter and No. 3 Biofilter sources at their hardboard manufacturing facility in Alpena, Michigan. The No. 1 Biofilter controls emissions from the No. 1 Board Press, and cooler (EUPRESS2S). The No. 3 Biofilter controls emissions from the No. 3 Board Press and cooler (EU3-PRESS-AREA). Both sources are grouped in the permit within the FGPRESSES and FGMACTDDDD flexible groups.

The objective of the testing was to evaluate compliance of the No. 1 Biofilter and No. 3 Biofilter sources with emission limits and requirements in:

- Michigan Department of Environmental Quality (MDEQ) Renewable Operating Permit (ROP) MI-ROP-B1476-2009a (currently being renewed) for the FGMACTDDDD sources, and
- 40 CFR 63, Subpart DDDD, "National Emission Standards for Hazardous Air Pollutants: Plywood and Composite Wood Products."

Bureau Veritas measured total hydrocarbons (THC), methanol, and formaldehyde at the inlet and outlet of the No. 1 Biofilter and No. 3 Biofilter control devices on September 17 and 18, 2015.

Three 60-minute compliance test runs were performed at each source under normal operating conditions following United States Environmental Protection Agency (USEPA) Methods 1 through 4, 25A, and 320.

## 1.2 Key Personnel

The key personnel involved in this test program are listed in Table 1-1 on the following page. Mr. Thomas Schmelter, Senior Project Manager with Bureau Veritas, led the emission testing. Mr. Dennis Werblow, Director of Environmental and Quality with Decorative Panels International, Inc., provided process coordination and recorded operating parameters. Mr. William Rogers Jr. and Mr. Jeremy Howe, Environmental Quality Analysts with MDEQ, witnessed portions of the testing. In addition, Ms. Natalie Topinka, Environmental Scientist, and Mr. Kenneth Ruffato, Environmental Engineer, with USEPA Region V, witnessed portions of the testing.



**Table 1-1  
Key Personnel**

<b>Facility Contact</b>	<b>Emission Testing Project Manager</b>
<p>Dennis Werblow            Director of Environmental and Quality  <b>Decorative Panels International, Inc.</b>            416 Ford Avenue            Alpena, Michigan 49707            Telephone: 989.356.8542            Facsimile: 989.356.2504            dennis.werblow@DecPanels.com</p>	<p>Thomas Schmelter, QSTI            Senior Project Manager  <b>Bureau Veritas North America, Inc.</b>            22345 Roethel Drive            Novi, Michigan 48375            Telephone: 248.344.3003            Facsimile: 248.344.2656            thomas.schmelter@us.bureauveritas.com</p>
<b>MDEQ Regulatory Agency</b>	<b>USEPA Regulatory Agency</b>
<p>Jeremy Howe            Environmental Quality Analyst  <b>Michigan Department of Environmental Quality</b>            Air Quality Division            Cadillac District Office            120 West Chapin Street            Cadillac, Michigan 49601-2158            Telephone: 231.876.4416            Facsimile: 231.775.1511            howej1@michigan.gov</p> <p>William J. Rogers Jr.            Environmental Quality Analyst  <b>Michigan Department of Environmental Quality</b>            Air Quality Division            Gaylord District Office            2100 West M-32            Gaylord, Michigan 49735-9282            Telephone: 989.705.3406            Facsimile: 989.731.6181            rogersw@michigan.gov</p>	<p>Natalie M. Topinka            Environmental Scientist  <b>United States Environmental Protection Agency</b>            Region V - Air Enforcement and Compliance Assurance            Ralph Metcalfe Federal Building            77 West Jackson Boulevard (AE-17J)            Chicago, Illinois 60604-3590            Telephone: 312.886.3853            topinka.natalie@epa.gov</p> <p>Kenneth Ruffato            Environmental Engineer  <b>United States Environmental Protection Agency</b>            Region V - Air Enforcement and Compliance Assurance            Ralph Metcalfe Federal Building            77 West Jackson Boulevard (AE-17J)            Chicago, Illinois 60604-3590            Telephone: 312.886.7886            ruffatto.kenneth@epa.gov</p>



---

## 2.0 Source and Sampling Locations

### 2.1 Process Description

Decorative Panels International, Inc. produces a variety of hardboard products including wall paneling, pegboard, and marker board. Hardwood chips, such as aspen, ash, maple, and beech chips, are purchased and stored in an outdoor raw material storage area and reclaimed into silos. The wood chips are cooked and softened in one of four digesters using steam injection and ground into wood pulp fibers.

The pulp fibers are conveyed to a forming machine, which forms a mat of un-pressed hardboard. The mats are processed through a Coe dryer and cut using a trimmer and panel brush. The mats are conveyed to one of two hardboard lines, Line 1 or 3. Line 2 was historically operated but has since been decommissioned.

On the hardboard lines, the mats enter a predryer, a press, cooler, and tempering area. The predryer ensures the mat has the desired moisture content before the mat enters presses that heat and form hardboard. The hardboard is coated with linseed or Oxi-Cure® oil in the tempering area. The oil tempers the board thereby increasing its strength and “paintability.” Once the board has been tempered, it is superheated to cure the binding resins in the bake ovens (No. 3 Press line only). The hardboard is humidified to approximate atmospheric conditions to limit warping. The boards are inspected, graded, cut, and packed for shipping.

The No. 1 Biofilter controls emissions from the No. 1 Board Press and cooler.

The No. 3 Biofilter controls emissions from the No. 3 Board Press and cooler.

### 2.2 Process Operating Parameters

The process was operated under normal operating conditions during testing. The facility was manufacturing ¼-inch thick board at the No. 1 and No. 3 Board Presses. For a standard production schedule under normal operating conditions, the rated capacity of the EUPRESS2S and EU3PRESS-AREA are as follows:

- **EUPRESS2S**                      580 to 620 thousand square feet per day
- **EU3-PRESS-AREA**              290 to 310 thousand square feet per day





Tables 2-1 and 2-2 summarize the number of press loads, boards, and production based on the number of THC concentration peaks that were measured during the test periods.

Refer to Appendix E for process data recorded during testing.

**Table 2-1  
Summary of EUPRESS2S Production Data**

Test Run	Press Loads	Boards Pressed	Production Rate
			msf/hour
1	18	360	23.04
2	16	320	20.48
3	21	420	26.88
<b>Average</b>	<b>18</b>	<b>367</b>	<b>23.47</b>

msf: thousand square feet

**Table 2-2  
Summary of EU3-PRESS-AREA Production Data**

Test Run	Press Loads	Boards Pressed	Production Rate
			msf/hour
1	18	360	11.50
2	17	340	10.88
3	19	380	12.16
<b>Average</b>	<b>18</b>	<b>360</b>	<b>11.52</b>

msf: thousand square feet

## 2.3 Control Equipment

### EUPRESS2S – No. 1 Biofilter

Gaseous emissions from the No. 1 Board Press are controlled by a DynaWave Engineering water scrubber and the No. 1 Biofilter. Emissions from the No. 1 Board Press are captured by a permanent total enclosure that surrounds the press area. The air from the enclosure continuously exhausts through a duct that exits the roof of the building and flows towards the pollution control equipment. The captured air (flue gas) enters the top of the scrubber and flows downwards in the vessel. Inside the vessel, water (containing sodium hydroxide to maintain a neutral pH) is



---

sprayed into the air to remove particulates and humidify the air before the air enters the biofilter. The water is sprayed onto a series of chevrons to increase the air-to-water contact surface area.

As the flue gas mixes with the water, particulates and other pollutants are removed. The water drains to the bottom of the vessel and a portion is recirculated into the system with the remaining portion discharged to the onsite water treatment system. The flue gas exits the top of the scrubber and flows into the No. 1 Biofilter.

The No. 1 Biofilter, manufactured by Monsanto Enviro-Chem., consists of six compartments. The air from the scrubber can be heated by a heat exchanger before being directed into the six-biobed compartments. The compartments contain water sprayers to maintain a moist environment, and layers of Douglas-fir bark from the western United States. The Douglas-fir bark provides an environment where biologically active microbes can oxidize and remove the contaminants.

After passing through the bark the flue gas is drawn into fans that discharge the gas through stack, SVS2COOLR-STK28.

#### **EU3-PRESS-AREA – No. 3 Biofilter**

Gaseous emissions from the No. 3 Board Press are controlled by a humidifier and Envirogen manufactured biofilter (No. 3 Biofilter). Emissions from the No. 3 Board Press enters the top of the scrubber and flows downwards in the vessel, where water treated with sodium hydroxide to maintain a neutral pH, is sprayed to humidify the inlet air to the biofilter.

As the gas mixes with the water, particulates and other pollutants are removed. The water drains to the bottom of the vessel and a portion is recirculated into the system with the remaining portion discharged to the onsite water treatment system. The flue gas exits the top of the scrubber and flows into the No. 3 Biofilter.

The No. 3 Biofilter consists of four compartments. The air exiting the humidifier can be further humidified and heated by adding steam into the ductwork upstream of the biobed compartments. The compartments contain water sprayers to maintain a moist environment, and layers of Douglas-fir bark from the western United States. The Douglas-fir bark provides an environment where biologically active microbes can oxidize and remove contaminants.

After passing through the bark the flue gas is drawn into fans that discharge the gas through stack, SV#3PRESS-STK68.

The biofilter bed temperatures are continuously monitored by multiple thermocouples in each chamber. These temperatures are reduced to 15-minute averages and recorded by the facility. The minimum and maximum 15-minute biofilter bed temperature operating requirements have been established based on previous performance tests. The established No. 1 Biofilter bed temperature range is 73 to 87°F and 73 to 92°F for the No. 3 Biofilter. The new maximum biofilter bed temperature limit of 92°F was established at the No. 3 Biofilter during Run 2 of the testing.



The No. 1 Biofilter and No. 3 Biofilter average bed temperatures during testing are presented in Tables 2-3 and 2-4. Refer to Appendix E for facility operating data.

**Table 2-3**  
**No. 1 Biofilter Bed Average Temperature During Testing**

Test Run	Minimum 15-minute Temperature (°F)	Maximum 15-minute Temperature (°F)	Average Temperature (°F)
1	79	79	79
2	79	80	80
3	79	79	79
<b>Average</b>	<b>79</b>	<b>79</b>	<b>79</b>

**Table 2-4**  
**No. 3 Biofilter Bed Average Temperature During Testing**

Test Run	Minimum 15-minute Temperature (°F)	Maximum 15-minute Temperature (°F)	Average Temperature (°F)
1	91	91	91
2	91	92	92
3	90	90	90
<b>Average</b>	<b>91</b>	<b>91</b>	<b>91</b>

## 2.4 Flue Gas Sampling Locations

The figures on the following pages provide photographs that show the sampling ports for the No. 1 Biofilter and No. 3 Biofilter sampling locations. Appendix Figures 1 through 4 present the No. 1 Biofilter and No. 3 Biofilter inlet and outlet sampling ports and traverse point locations.

**Figure 2-1. No. 1 Biofilter Inlet Sampling Location**



**Figure 2-2. No. 1 Biofilter Outlet Sampling Location**

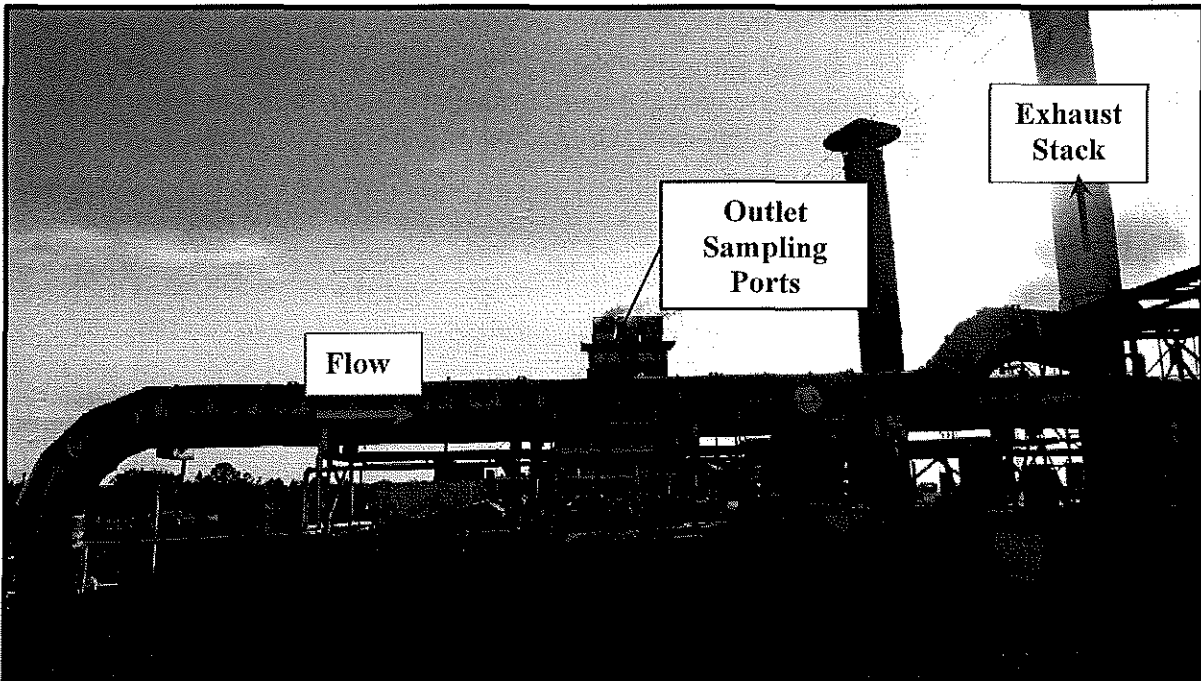

**Figure 2-3. No. 3 Biofilter Inlet and Outlet Sampling Locations**

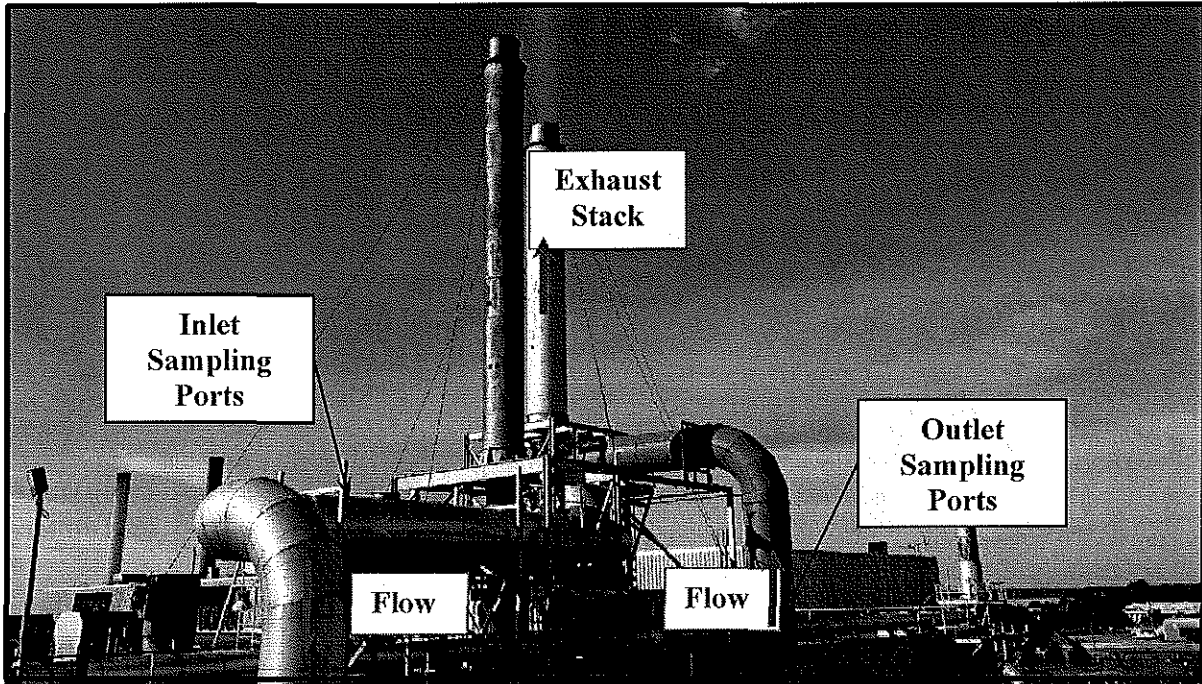

## **2.5 Process Sampling Locations**

Process sampling was not required during this test program. A process sample is a sample that is analyzed for operational parameters, such as calorific value of a fuel (e.g., natural gas, coal), organic compound content (e.g., paint coatings), or composition (e.g., polymers).



---

## 3.0 Summary and Discussion of Results

### 3.1 Objectives and Test Matrix

The objective of the testing was to satisfy testing requirements and evaluate compliance of the No. 1 Biofilter and No. 3 Biofilter sources with emission limits and requirements in:

- MDEQ ROP: MI-ROP-B1476-2009a (currently being renewed) for the FGMACTDDDD sources.
- 40 CFR 63, Subpart DDDD, "National Emission Standards for Hazardous Air Pollutants: Plywood and Composite Wood Products."

Compliance with the FGMACTDDDD total hazardous air pollutant (HAP) permit limits, based on the use of an add-on control device, can be demonstrated by any one of the following criteria:

1. 90% reduction of total HAP mass emission rate, measured as THC, as carbon.
2. Total HAP concentration less than 20 part per million by volume, dry (ppmvd), measured as THC (as carbon).
3. Total HAP reduction so that methanol mass emission rate is reduced by 90%.
4. Total HAP reduction so that methanol concentration is less than 1 ppmvd, if the uncontrolled methanol concentration entering the control device is greater than 10 ppmvd.
5. Total HAP reduction so that formaldehyde mass emission rate is reduced by 90%.
6. Total HAP reduction so that formaldehyde concentration is less than 1 ppmvd, if the uncontrolled formaldehyde entering the control device is greater than 10 ppmvd.

Bureau Veritas measured THC, methanol, and formaldehyde at the:

- Inlet and outlet stack of No.1 Biofilter
- Inlet and outlet stack of No.3 Biofilter

Table 3-1 summarizes the sampling and analytical test matrix.



**Table 3-1  
Sampling and Analytical Matrix**

Sampling Location	Sample/ Type of Pollutant	Sample Method	Date (2015)	Run	Start Time	End Time	Analytical Method	Analytical Laboratory	Comment
Inlet and Outlet of No. 1 Biofilter	Flowrate, molecular weight, moisture content, formaldehyde, methanol, total hydrocarbons	EPA 1, 2, 3, 4, 25A, 320	Sept. 17	1	9:00	10:00	Pitot tube, chemical absorption analyzer, flame ionization analyzer, Fourier transform infrared analyzer	Bureau Veritas	Compliance tests
				2	11:45	12:45			
				3	13:15	14:15			
Inlet and Outlet of No. 3 Biofilter	Flowrate, molecular weight, moisture content, formaldehyde, methanol, total hydrocarbons	EPA 1, 2, 3, 4, 25A, 320	Sept. 18	1	8:45	9:45	Pitot tube, chemical absorption analyzer, flame ionization analyzer, Fourier transform infrared analyzer	Bureau Veritas	Compliance tests
				2	10:05	11:05			
				3	18:00	19:00			

### 3.2 Field Test Changes and Issues

The testing was performed in accordance with USEPA procedures, during normal operating conditions, as outlined in the original Intent-to-Test Plan submitted to MDEQ on August 14, 2015, and approved on September 4, 2015.

No field test changes or issues were encountered during the test program, with the exception that Run 3 of the No. 3 Biofilter testing was delayed due to a malfunction and subsequent repair of the press from approximately 11:30 to 17:30. Run 3 was conducted after the facility verified the press was operating at normal operating conditions.

### 3.3 Summary of Results

Detailed results are presented in Tables 1 through 4 after the Tables Tab of this report. The results of the testing and a comparison to permit limits are presented in Tables 3-2 through 3-5.



## No. 1 Biofilter Formaldehyde, Methanol, and THC Results

**Table 3-2**  
**No. 1 Biofilter Formaldehyde, Methanol, and THC Results**

Parameter	Units	Run 1	Run 2	Run 3	Average
Formaldehyde inlet concentration	ppmvd	34.3	28.9	34.5	<b>32.5</b>
Formaldehyde inlet emission rate	lb/hr	8.3	7.0	8.3	<b>7.8</b>
Formaldehyde outlet concentration	ppmvd	1.1	1.0	1.1	<b>1.1</b>
Formaldehyde outlet emission rate	lb/hr	0.3	0.3	0.3	<b>0.3</b>
Formaldehyde removal efficiency	%	96.4	95.8	96.3	<b>96.2</b>
Methanol inlet concentration	ppmvd	44.2	36.5	45.6	<b>42.1</b>
Methanol inlet emission rate	lb/hr	11.4	9.4	11.7	<b>10.8</b>
Methanol outlet concentration	ppmvd	10	6.3	8.6	<b>8.3</b>
Methanol outlet concentration	lb/hr	3.0	1.9	2.5	<b>2.5</b>
Methanol removal efficiency	%	73.9	79.7	78.2	<b>77.3</b>
THC inlet concentration as carbon	ppmvd	384	286	354	<b>341</b>
THC inlet emission rate as carbon	lb/hr	37.2	27.6	34.0	<b>32.9</b>
THC outlet concentration as carbon	ppmvd	48.3	38.7	43.6	<b>43.5</b>
THC outlet emission rate as carbon	lb/hr	5.4	4.4	4.8	<b>4.9</b>
THC removal efficiency	%	85.6	84.2	85.8	<b>80.7</b>

Note: The average biofilter bed temperature during the three test runs was 79°F.

The results of the September 17, 2015 emissions testing established the following:

- The No. 1 Biofilter source complies with the formaldehyde destruction efficiency limit of 90% or greater at a biofilter bed temperature within the previously established compliance range of 73 to 87°F.





## No. 3 Biofilter Formaldehyde, Methanol, and THC Results

**Table 3-3**  
**No. 3 Biofilter Formaldehyde, Methanol, and THC Results**

Parameter	Units	Run 1	Run 2	Run 3	Average
Formaldehyde inlet concentration	ppmvd	15.5	14.5	15.5	<b>15.2</b>
Formaldehyde inlet emission rate	lb/hr	2.9	2.8	3.0	<b>2.9</b>
Formaldehyde outlet concentration	ppmvd	0.8	0.9	0.5	<b>0.7</b>
Formaldehyde outlet emission rate	lb/hr	0.2	0.2	0.1	<b>0.2</b>
Formaldehyde removal efficiency	%	93.3	93.2	95.9	<b>94.1</b>
Methanol inlet concentration	ppmvd	22.3	23.9	24.2	<b>23.5</b>
Methanol inlet emission rate	lb/hr	4.4	4.9	5.0	<b>4.8</b>
Methanol outlet concentration	ppmvd	5.6	6.2	4.5	<b>5.4</b>
Methanol outlet concentration	lb/hr	1.4	1.5	1.1	<b>1.3</b>
Methanol removal efficiency	%	68.9	69.9	77.7	<b>72.2</b>
THC inlet concentration as carbon	ppmvd	228	242	256	<b>242</b>
THC inlet emission rate as carbon	lb/hr	17	19	20	<b>18.4</b>
THC outlet concentration as carbon	ppmvd	44.6	44.3	31.9	<b>40.2</b>
THC outlet emission rate as carbon	lb/hr	4.1	4.0	3.0	<b>3.7</b>
THC removal efficiency as carbon	%	76.0	78.7	84.9	<b>79.9</b>

Note: The average biofilter bed temperature during the three test runs was 91°F.

The results of the September 18, 2015 emissions testing established the following:

- The No. 3 Biofilter source complies with the formaldehyde destruction efficiency limit of (1) 90% or greater and (2) formaldehyde concentration limit of <1 ppmvd when a formaldehyde concentration greater than 10 ppmvd is entering the control devices at a biofilter bed temperature within the compliance range of 73 to 92°F. The minimum biofilter bed temperature limit was established during a previous performance test; the maximum biofilter bed temperature of 92°F was established during Run 2 of the testing.



## 4.0 Sampling and Analytical Procedures

Bureau Veritas measured emissions following the guidelines and procedures specified in 40 CFR 51, Appendix M, "Recommended Test Methods for State Implementation Plans," 40 CFR 60, Appendix A, "Standards of Performance for New Stationary Sources," 40 CFR 63, Appendix A, "Test Methods Pollutant Measurement Methods from Various Waste Media," and State of Michigan Part 10 Rules, "Intermittent Testing and Sampling." The sampling and analytical methods used are presented in Table 4-1.

**Table 4-1  
Emission Test Methods**

Method	Parameter	Analysis
EPA 1 and 2	Gas stream volumetric flowrate	Field measurement, S-type Pitot tube
EPA 3	molecular weight	Fyrite® chemical absorption
EPA 4	Moisture content	Gravimetric
EPA 25A	Total hydrocarbons	Flame ionization detector
EPA 205	Gas dilution calibration	Field verification
EPA 320	Formaldehyde and methanol	Extractive Fourier transform infrared spectroscopy (FTIR)

### 4.1 Emission Test Methods

The table below outlines the test methods for the test parameters, including ancillary measurements required by the USEPA methods (i.e., traverse point selection, velocity, molecular weight, and moisture content).



**Table 4-2  
Emission Test Parameters**

Parameter	Source		USEPA Reference	
	Inlet of No. 1 and No. 3 Biofilter	Outlet of No. 1 and No. 3 Biofilter	Method	Title
Sampling ports and traverse points	●	●	1	Sample and Velocity Traverses for Stationary Sources
Velocity and flowrate	●	●	2	Determination of Stack Gas Velocity and Volumetric Flow Rate (Type S Pitot Tube)
Molecular weight	●	●	3	Gas Analysis for the Determination of Dry Molecular Weight
Moisture content	●	●	4	Determination of Moisture Content in Stack Gases
Total hydrocarbons	●	●	25A	Determination of Total Gaseous Organic Concentration using a Flame Ionization Analyzer
Gas dilution calibration	●	●	205	Verification of Gas Dilution Systems for Field Instrument Calibrations
Formaldehyde and methanol	●	●	320	Measurement of Vapor Phase Organic and Inorganic Emissions by Extractive Fourier Transform Infrared (FTIR) Spectroscopy

#### **4.1.1 Volumetric Flowrate (USEPA Methods 1 and 2)**

Method 1, "Sample and Velocity Traverses for Stationary Sources," from the Code of Federal Regulations, Title 40, Part 60 (40 CFR 60), Appendix A, was used to evaluate the sampling location, the number of traverse points for sampling, and the measurement of velocity profiles. Details of the sampling location and number of velocity traverse points are presented in Table 4-3.



**Table 4-3**  
**Sampling Location and Number of Traverse Points**

Source	Sampling Location	Duct Diameter  (inches)	Distance from Ports to Upstream Flow Disturbance  (diameters)	Distance from Ports to Downstream Flow Disturbance  (diameters)	Number of Ports Used	Traverse Points per Port	Total Traverse Points	Cyclonic Flow Null Angle (°)
No. 1 Biofilter	Inlet	59.75	8.8	8.0	2	12	24	2
No. 1 Biofilter	Outlet	59.25	7.6	3.4	2	12	24	2
No. 3 Biofilter	Inlet	51	2.6	1.5	2	12	24	2
No. 3 Biofilter	Outlet	51.25	5.9	3.5	2	12	24	3

Figures 2-1 through 2-3 are photographs depicting the sampling locations at the No. 1 and No. 3 Biofilter sources. Appendix Figures 1 through 4 present the No. 1 and No. 3 Biofilter's inlet and outlet sampling ports and traverse point locations.

Method 2, "Determination of Stack Gas Velocity and Volumetric Flow Rate (Type S Pitot Tube)," was used to measure flue gas velocity and calculate volumetric flowrate. S-type Pitot tubes and thermocouple assemblies, calibrated in accordance with Method 2, Section 10.0, were used during testing. Because the dimensions of the Pitot tubes met the requirements outlined in Method 2, Section 10.1, and were within the specified limits, the baseline Pitot tube coefficient of 0.84 (dimensionless) was assigned. Refer to Appendix A for the Pitot tube inspection sheets.

**Cyclonic Flow Check.** Bureau Veritas evaluated whether cyclonic flow was present at the sampling locations. Cyclonic flow is defined as a flow condition with an average null angle greater than 20°. The direction of flow can be determined by aligning the Pitot tube to obtain zero (null) velocity head reading—the direction would be parallel to the Pitot tube face openings or perpendicular to the null position. By measuring the angle of the Pitot tube face openings in relation to the stack walls when a null angle is obtained, the direction of flow is measured. If the absolute average of the flow direction angles is greater than 20 degrees, the flue gas is considered cyclonic at that sampling location and an alternative location should be found.

The averages of the measured traverse point flue gas velocity null angles were:

- 2° from the direction of flow for the No. 1 Biofilter inlet
- 2° from the direction of flow for the No. 1 Biofilter outlet



- 
- 2° from the direction of flow for the No. 3 Biofilter inlet
  - 3° from the direction of flow for the No. 3 Biofilter outlet

The measurements indicate the absence of cyclonic flow at the biofilter sampling locations. Field data sheets are included in Appendix C. Computer-generated field data sheets are included in Appendix D.

#### **4.1.2 Molecular Weight (USEPA Method 3)**

Molecular weight at the No. 1 and No. 3 Biofilter locations was measured using USEPA Method 3, "Gas Analysis for the Determination of Dry Molecular Weight." Flue gas was extracted from the stack through a probe positioned near the centroid of the duct and directed into a Fyrite® gas analyzer. The concentrations of carbon dioxide (CO<sub>2</sub>) were measured by chemical absorption to within ±0.5%. The average CO<sub>2</sub> results of the grab samples were used to calculate molecular weight.

#### **4.1.3 Moisture Content (USEPA Method 4)**

The moisture content of the flue gas was measured using the reference methods outlined in USEPA Method 4, "Determination of Moisture Content in Stack Gases," and USEPA Method 320, "Measurement of Vapor Phase Organic and Inorganic Emissions by Extractive Fourier Transform Infrared (FTIR) Spectroscopy."

#### **4.1.4 Total Hydrocarbons (USEPA Method 25A)**

The THC sampling followed USEPA Method 25A, "Determination of Total Gaseous Organic Concentration Using a Flame Ionization Analyzer" procedures. Samples were collected through a stainless steel probe and heated sample line into the analyzer. Bureau Veritas used J.U.M. manufactured flame ionization detector based hydrocarbon analyzers. Figure 5 in the Appendix depicts the USEPA Method 25A sampling train.

A flame ionization detector (FID) determines the average hydrocarbon concentration in part per million by volume (ppmv) of THC as the calibration gas (i.e., propane). The FID is fueled by 100% hydrogen, which generates a flame with a negligible number of ions. Flue gas is introduced into the FID and enters the flame chamber. The combustion of flue gas generates electrically charged ions. The analyzer applies a polarizing voltage between two electrodes around the flame, producing an electrostatic field. Negatively charged ions, anions, migrate to a collector electrode, while positive charged ions, cations, migrate to a high-voltage electrode. The current between the electrodes is directly proportional to the hydrocarbon concentration in the sample. The flame chamber is depicted at right.

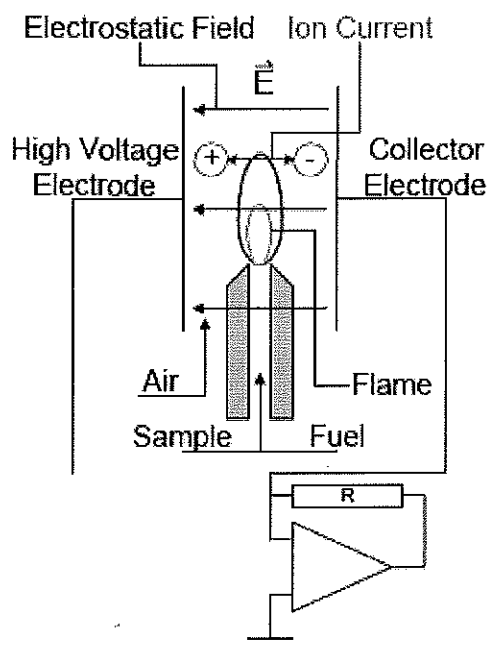

**Figure 4-1. FID Flame Chamber**

Using the voltage analog signal, measured by the FID, the concentration of total hydrocarbons is recorded by a data acquisition system (DAS). The average concentration of total hydrocarbons is reported as the calibration gas (i.e., propane) in equivalent units.

Before testing, the FID analyzers were calibrated by introducing a zero-calibration range gas (<1% of span value) and high-calibration range gas (80-90% span value) to the tip of the sampling probe. The span values were set to 1.5 to 2.5 times the expected concentration (e.g., 0-100 ppmv). Next, a low-calibration range gas (25-35% of span value) and mid-calibration range gas (45-55% of span value) were introduced. The analyzers were considered to be calibrated when the analyzer response was  $\pm 5\%$  of the calibration gas value.

At the conclusion of a test run a calibration drift test was performed by introducing the zero- and mid-calibration gases to the tip of the sampling probe. The test run data were considered valid if the calibration drift test demonstrated the analyzers responded within  $\pm 3\%$  of calibration span from pre-test to post-test calibrations.

#### 4.1.5 Formaldehyde and Methanol (USEPA Method 320)

Formaldehyde and methanol emissions were measured in accordance with USEPA Method 320, "Measurements of Vapor Phase Organic and Inorganic Emissions by Extractive Fourier Transform Infrared (FTIR) Spectroscopy." Gaseous samples were withdrawn from the stack and transferred to MKS Instruments MultiGas 2030 FTIR spectrometers for formaldehyde and



methanol measurements. Figure 6 in the Appendix depicts the USEPA Method 320 sampling train.

The samples were directed through a heated probe, heated filter and heated transfer line connected to the FTIR. The probes, filters, transfer lines, and FTIRs were maintained at 191° C (375° F) during testing. The formaldehyde and methanol concentrations were measured based on their infrared absorbance compared to reference spectra. The FTIR analyzer scans the sample approximately once per second. A data point consists of the co-addition of 64 scans, with a data point generated every minute.

FTIR quality assurance procedures followed USEPA Method 320. A calibration transfer standard (CTS) was analyzed before and after testing. Acetaldehyde and methanol analyte spiking was performed before the tests. Section 3.29 of USEPA Method 320 allows the use of a surrogate analyte for the purposes of analyte spiking. Acetaldehyde was chosen as surrogate to formaldehyde for the following reasons:

- The highest obtainable formaldehyde cylinder is 30 ppm; therefore, the spiked concentration would be 3 ppm (analyte spiking consists of sampling 1 part calibration gas in the presence of 9 parts effluent gas). The formaldehyde concentrations of the sources tested were much higher than 3 ppm.
- Acetaldehyde's physical and chemical properties are similar to those of formaldehyde. Formaldehyde is the C<sub>1</sub> aldehyde (CH<sub>2</sub>O); acetaldehyde is the C<sub>2</sub> aldehyde (CH<sub>3</sub>CHO).

The analyte spikes were set to a target dilution ratio of 1:10 or less. Valid tests required acetaldehyde and methanol spike recoveries to be within the Method 320 allowance of ±30%.

#### **4.1.6 Gas Dilution (USEPA Method 205)**

A gas dilution system was used to introduce known values of calibration gases into the THC analyzers. The gas dilution system consisted of calibrated mass flow controllers. The system diluted a high-level calibration gas to within ±2% of predicted values. This gas divider was capable of diluting gases at various increments.

Before the start of testing, the gas divider dilutions were verified to be within ±2% of predicted values. Two sets of dilutions of the high-level (851.1 ppmv propane) calibration gas were performed. Subsequently, a certified mid-level calibration gas (478 ppmv propane) was introduced into the analyzer; the calibration gas concentration was within ±10% of a dilution. Table 4-4 presents the USEPA Method 205 gas dilution field verification measurements.



**Table 4-4  
Gas Dilution Field Verification**

Expected/Actual Concentration	Acceptable Range†		Actual Concentration 1	Actual Concentration 2	Actual Concentration 3	Pass?
	Low	High				
(ppmv)	(ppmv)	(ppmv)	(ppmv)	(ppmv)	(ppmv)	
300	294	306	300	299	299	Yes
500	490	510	500	494	495	Yes
478	468	488	470	469	469	Yes

† Acceptable range is  $\pm 2\%$  of the expected concentration

The field calibrations verified the accuracy of the gas dilution system. Refer to Appendix A for the calibration gas certifications and gas dilution field calibrations.

## **4.2 Procedures for Obtaining Process Data**

Process data was recorded by Decorative Panels International, Inc. personnel during testing. The number of press loads was obtained from the number of THC concentration peaks recorded during testing. Refer to Section 2.1 and 2.2 for discussions of process and control device data and Appendix E for the operating parameters recorded during testing.





---

## 5.0 QA/QC Activities

### 5.1 Pretest QA/QC Activities

Before testing, the sampling equipment was cleaned, inspected, and calibrated according to procedures outlined in the applicable USEPA sampling method and USEPA's "Quality Assurance Handbook for Air Pollution Measurement Systems, Volume and Principles" and, Volume III, "Stationary Source Specific Methods." Refer to Appendix A for inspection and calibration sheets.

### 5.2 QA/QC Audits

The results of select sampling and equipment QA/QC audits and the acceptable USEPA tolerance are presented in the following sections.

#### 5.2.1 Instrument Analyzer QA/QC Audits

The FID and FTIR analyzers met the QA/QC requirements of USEPA Methods 25A and 320. The analyzers were calibrated using USEPA Traceability Protocol or Certified Standard calibration gases with an uncertainty  $\pm 2\%$  of certified value. FID calibration error tests indicated the analyzers were responding to  $\pm 5.0\%$  of the cylinder concentration and did not drift more than  $\pm 3\%$  after each test run. The FTIR analyzers passed all QA/QC procedures included acetaldehyde and methanol spike recoveries within the  $\pm 30\%$  allowance.

Refer to Appendix A for the calibration gas certificates and analyzer calibration data and Appendix F for the FTIR calibration data.

### 5.3 QA/QC Problems

QA/QC problems were not encountered during this test program.



---

## Limitations

The information and opinions rendered in this report are exclusively for use by Decorative Panels International, Inc. Bureau Veritas North America, Inc. will not distribute or publish this report without Decorative Panels International, Inc.'s consent except as required by law or court order. The information and opinions are given in response to a limited assignment and should be implemented only in light of that assignment. Bureau Veritas North America, Inc. accepts responsibility for the competent performance of its duties in executing the assignment and preparing reports in accordance with the normal standards of the profession, but disclaims any responsibility for consequential damages.

This report prepared by: *Thomas R. Schmelter*  
Thomas R. Schmelter, QSTI  
Senior Project Manager  
Health, Safety, and Environmental Services

This report reviewed by: *Derek R. Wong*  
Derek R. Wong, Ph.D., P.E.  
Director and Vice President  
Health, Safety, and Environmental Services



**Table 1**  
**No. 1 Biofilter Evaluation Results**  
**Decorative Panels International, Inc.**  
**Alpena, Michigan**  
**Bureau Veritas Project No. 11015-000211.00**  
**Sampling Date: September 17, 2015**

Parameter		Units	Run 1	Run 2	Run 3	Average
Sampling Time			9:00 - 10:00	11:45 - 12:45	13:15 - 14:15	
Duration		minutes	60	60	60	60
Board thickness		inch	0.25	0.25	0.25	0.25
<b>Inlet</b>						
Average Gas Stream Volumetric Flowrate		scfm	52,900	52,930	52,642.4	52,824
Gas Stream Percent Moisture Content		%	2.3	2.4	2.6	2.4
Formaldehyde Concentration		ppmv, as CH <sub>2</sub> O	33.5	28.2	33.6	31.8
Formaldehyde Concentration		ppmvd, as CH <sub>2</sub> O	34.3	28.9	34.5	32.5
Formaldehyde Mass Emission Rate		lb/hr, as CH <sub>2</sub> O	8.3	7.0	8.3	7.8
Methanol Concentration		ppmv, CH <sub>3</sub> OH	43.1	35.6	44.4	41.1
Methanol Concentration		ppmvd, CH <sub>3</sub> OH	44.2	36.5	45.6	42.1
Methanol Mass Emission Rate		lb/hr, as CH <sub>3</sub> OH	11.4	9.4	11.7	10.8
THC Concentration		ppmv, as propane	125	93.0	115	111
THC Concentration		ppmv, as carbon	375	279	345	333
THC Concentration		ppmvd, as carbon	384	286	354	341
THC Mass Emission Rate		lb/hr, as propane	45.4	33.7	41.5	40.2
THC Mass Emission Rate		lb/hr, as carbon	37.2	27.6	34.0	32.9
<b>Outlet</b>						
Gas Stream Volumetric Flowrate		scfm	62,420	63,626	62,289	62,778
Gas Stream Percent Moisture Content		%	4.9	5.0	5.1	5.0
Formaldehyde Concentration		ppmv, as CH <sub>2</sub> O	1.0	1.0	1.1	1.0
Formaldehyde Concentration		ppmvd, as CH <sub>2</sub> O	1.1	1.0	1.1	1.1
Formaldehyde Mass Emission Rate		lb/hr, as CH <sub>2</sub> O	0.3	0.3	0.3	0.3
Methanol Concentration		ppmv, CH <sub>3</sub> OH	9.5	6.0	8.2	7.9
Methanol Concentration		ppmvd, CH <sub>3</sub> OH	10	6.3	8.6	8.3
Methanol Mass Emission Rate		lb/hr, as CH <sub>3</sub> OH	3.0	1.9	2.5	2.5
THC Concentration		ppmv, as propane	15.3	12.2	13.8	13.8
THC Concentration		ppmv, as carbon	46.0	36.7	41.4	41.4
THC Concentration		ppmvd, as carbon	48.3	38.7	43.6	43.5
THC Mass Emission Rate		lb/hr, as propane	6.6	5.3	5.9	5.9
THC Mass Emission Rate		lb/hr, as carbon	5.4	4.4	4.8	4.9
<b>Formaldehyde Removal Efficiency Results</b>		%	96.4	95.8	96.3	96.2
<b>Methanol Removal Efficiency Results</b>		%	73.9	79.7	78.2	77.3
<b>No. 1 Biofilter THC Removal Efficiency Results</b>		%	85.6	84.2	85.8	80.7
Standard conditions		68°F and 29.92 in Hg				
	lb/hr	pound per hour				
	scfm	standard cubic feet per minute				
	ppmv	part per million by volume				
	ppmvd	part per million by volume dry basis				



**Table 2**  
**No. 3 Biofilter Evaluation Results**  
**Decorative Panels International, Inc.**  
**Alpena, Michigan**  
**Bureau Veritas Project No. 11015-000211.00**  
**Sampling Date: September 18, 2015**

Parameter		Units	Run 1	Run 2	Run 3	Average
Sampling Time			8:45 - 9:45	10:05 - 11:05	18:00 - 19:00	
Duration		minutes	60	60	60	60
Board thickness		inch	0.25	0.25	0.25	0.25
<b>Inlet</b>						
Average Gas Stream Volumetric Flowrate		scfm	40,617	42,490	42,113	41,740
Gas Stream Percent Moisture Content		%	2.8	2.8	2.7	2.8
Formaldehyde Concentration		ppmv, as CH <sub>2</sub> O	15.0	14.1	15.1	14.7
Formaldehyde Concentration		ppmvd, as CH <sub>2</sub> O	15.5	14.5	15.5	15.2
Formaldehyde Mass Emission Rate		lb/hr, as CH <sub>2</sub> O	2.9	2.8	3.0	2.9
Methanol Concentration		ppmv, CH <sub>3</sub> OH	21.7	23.2	23.6	22.8
Methanol Concentration		ppmvd, CH <sub>3</sub> OH	22.3	23.9	24.2	23.5
Methanol Mass Emission Rate		lb/hr, as CH <sub>3</sub> OH	4.4	4.9	5.0	4.8
THC Concentration		ppmv, as propane	74.0	78.2	83.1	78.5
THC Concentration		ppmv, as carbon	222	235	249	235
THC Concentration		ppmvd, as carbon	228	242	256	242
THC Mass Emission Rate		lb/hr, as propane	21	23	24	22.5
THC Mass Emission Rate		lb/hr, as carbon	17	19	20	18.4
<b>Outlet</b>						
Gas Stream Volumetric Flowrate		scfm	51,058	50,467	51,936	51,153.5
Gas Stream Percent Moisture Content		%	4.7	4.7	4.5	4.6
Formaldehyde Concentration		ppmv, as CH <sub>2</sub> O	0.8	0.8	0.5	0.7
Formaldehyde Concentration		ppmvd, as CH <sub>2</sub> O	0.8	0.9	0.5	0.7
Formaldehyde Mass Emission Rate		lb/hr, as CH <sub>2</sub> O	0.2	0.2	0.1	0.2
Methanol Concentration		ppmv, CH <sub>3</sub> OH	5.4	5.9	4.3	5.2
Methanol Concentration		ppmvd, CH <sub>3</sub> OH	5.6	6.2	4.5	5.4
Methanol Mass Emission Rate		lb/hr, as CH <sub>3</sub> OH	1.4	1.5	1.1	1.3
THC Concentration		ppmv, as propane	14.2	14.1	10.1	12.8
THC Concentration		ppmv, as carbon	42.5	42.2	30.4	38.4
THC Concentration		ppmvd, as carbon	44.6	44.3	31.9	40.2
THC Mass Emission Rate		lb/hr, as propane	5.0	4.9	3.6	4.5
THC Mass Emission Rate		lb/hr, as carbon	4.1	4.0	3.0	3.7
<b>Formaldehyde Removal Efficiency Results</b>		%	<b>93.3</b>	<b>93.2</b>	<b>95.9</b>	<b>94.1</b>
<b>Methanol Removal Efficiency Results</b>		%	<b>68.9</b>	<b>69.9</b>	<b>77.7</b>	<b>72.2</b>
<b>No. 1 Biofilter THC Removal Efficiency Results</b>		%	<b>76.0</b>	<b>78.7</b>	<b>84.9</b>	<b>79.9</b>
Standard conditions	68°F and 29.92 in Hg					
lb/hr	pound per hour					
scfm	standard cubic feet per minute					
ppmv	part per million by volume					
ppmvd	part per million by volume dry basis					

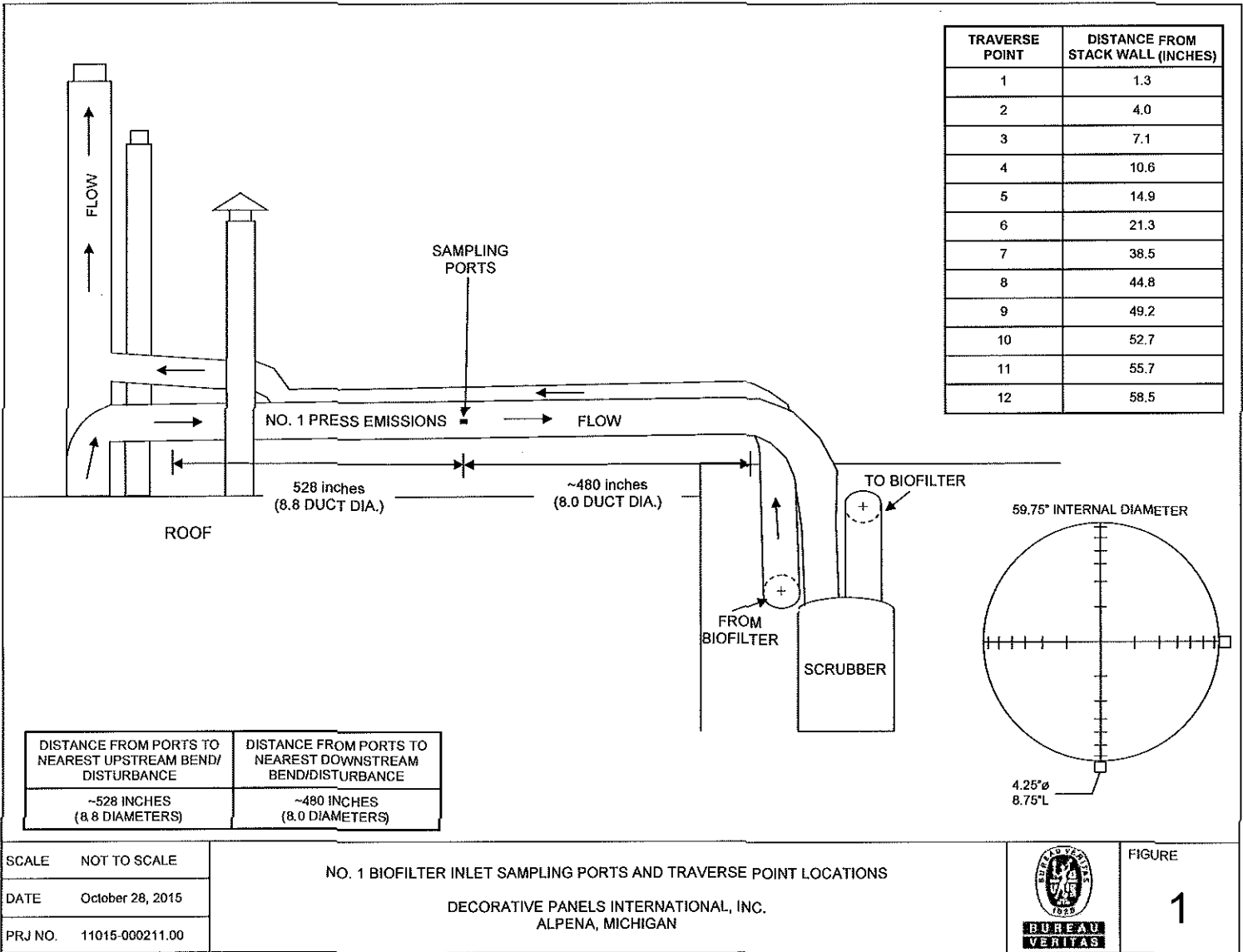

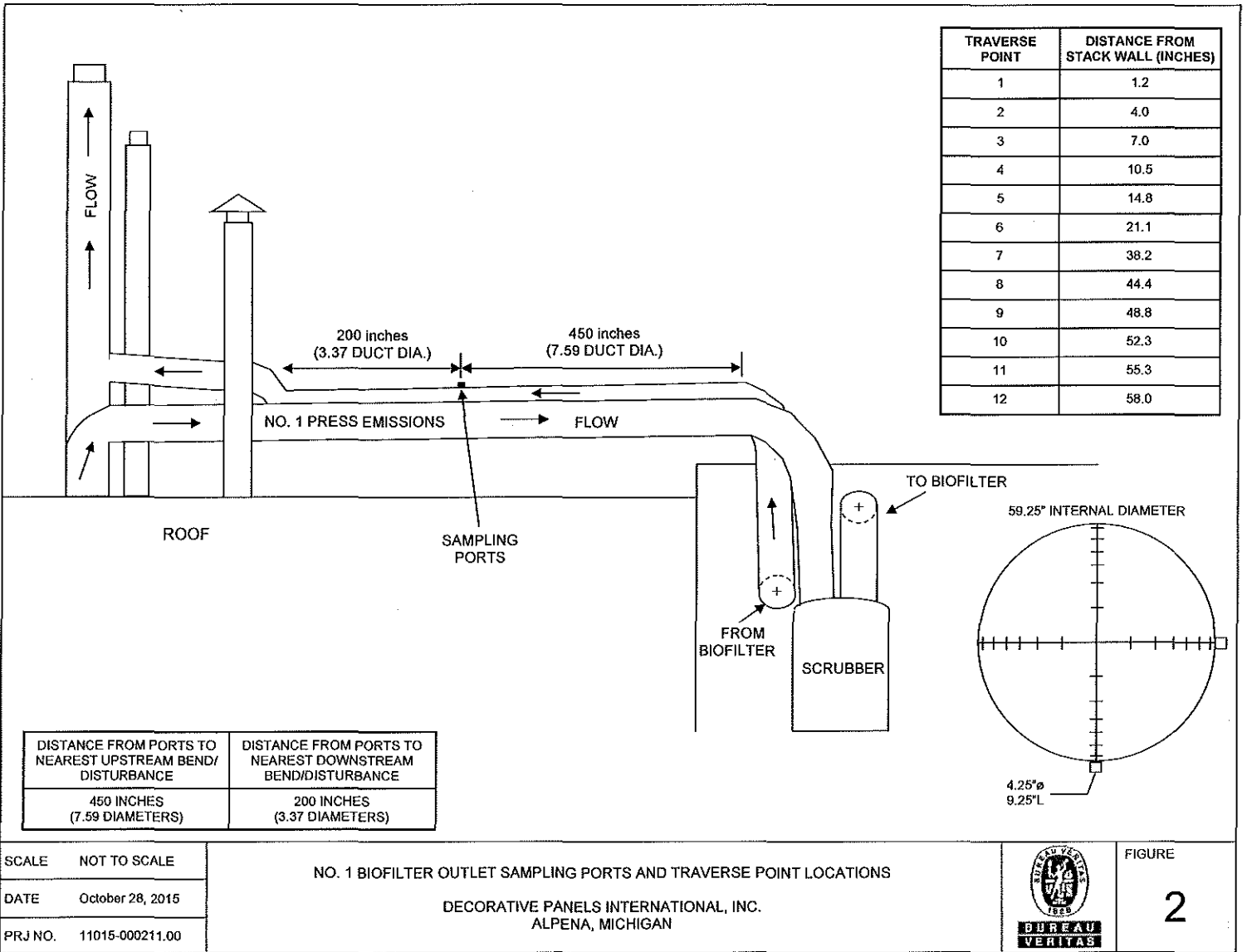

SCALE NOT TO SCALE  
 DATE October 28, 2015  
 PRJ NO. 11015-000211.00

NO. 1 BIOFILTER OUTLET SAMPLING PORTS AND TRAVERSE POINT LOCATIONS  
 DECORATIVE PANELS INTERNATIONAL, INC.  
 ALPENA, MICHIGAN



FIGURE  
**2**

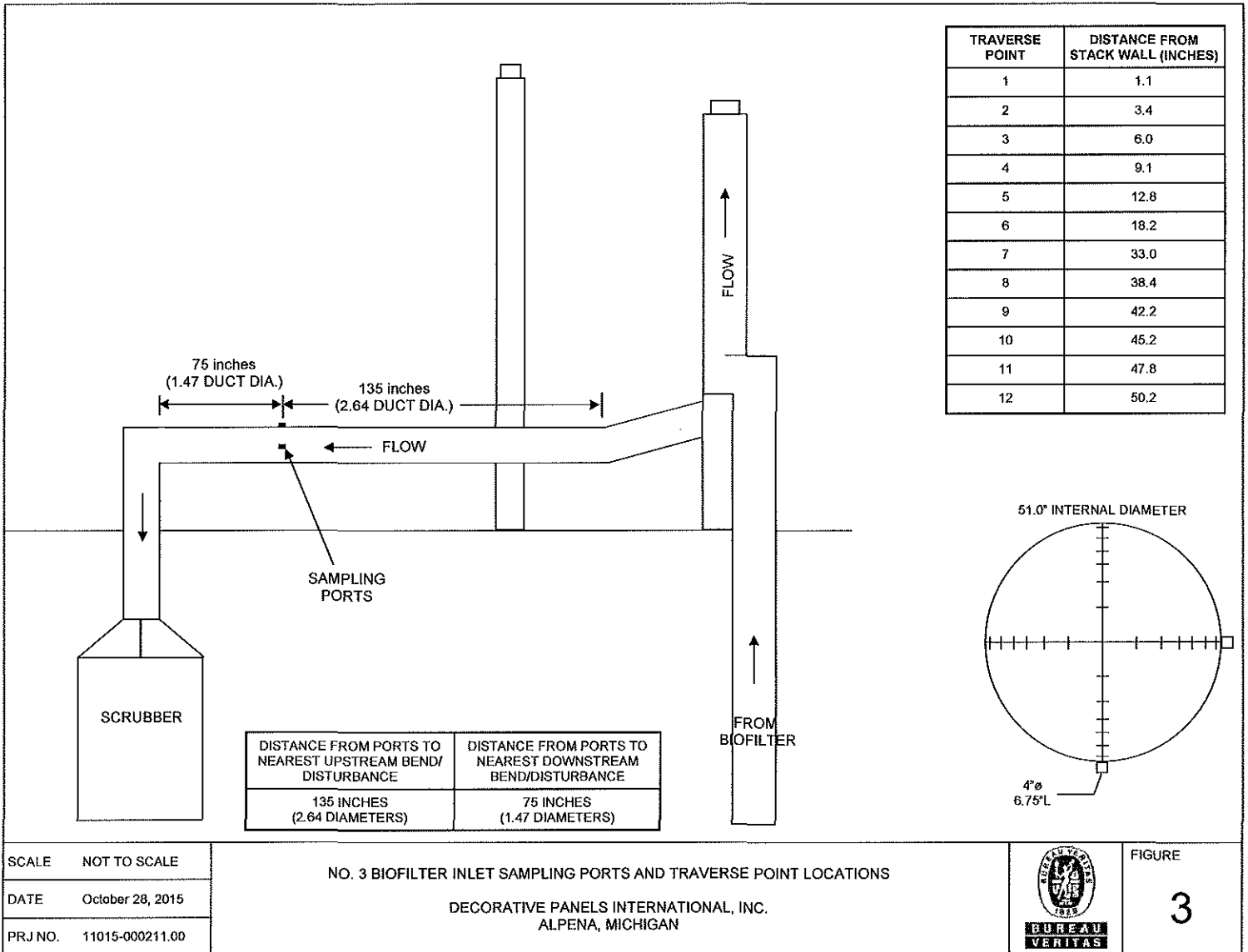

SCALE NOT TO SCALE  
 DATE October 28, 2015  
 PRJ NO. 11015-000211.00

NO. 3 BIOFILTER INLET SAMPLING PORTS AND TRAVERSE POINT LOCATIONS  
 DECORATIVE PANELS INTERNATIONAL, INC.  
 ALPENA, MICHIGAN



FIGURE  
**3**

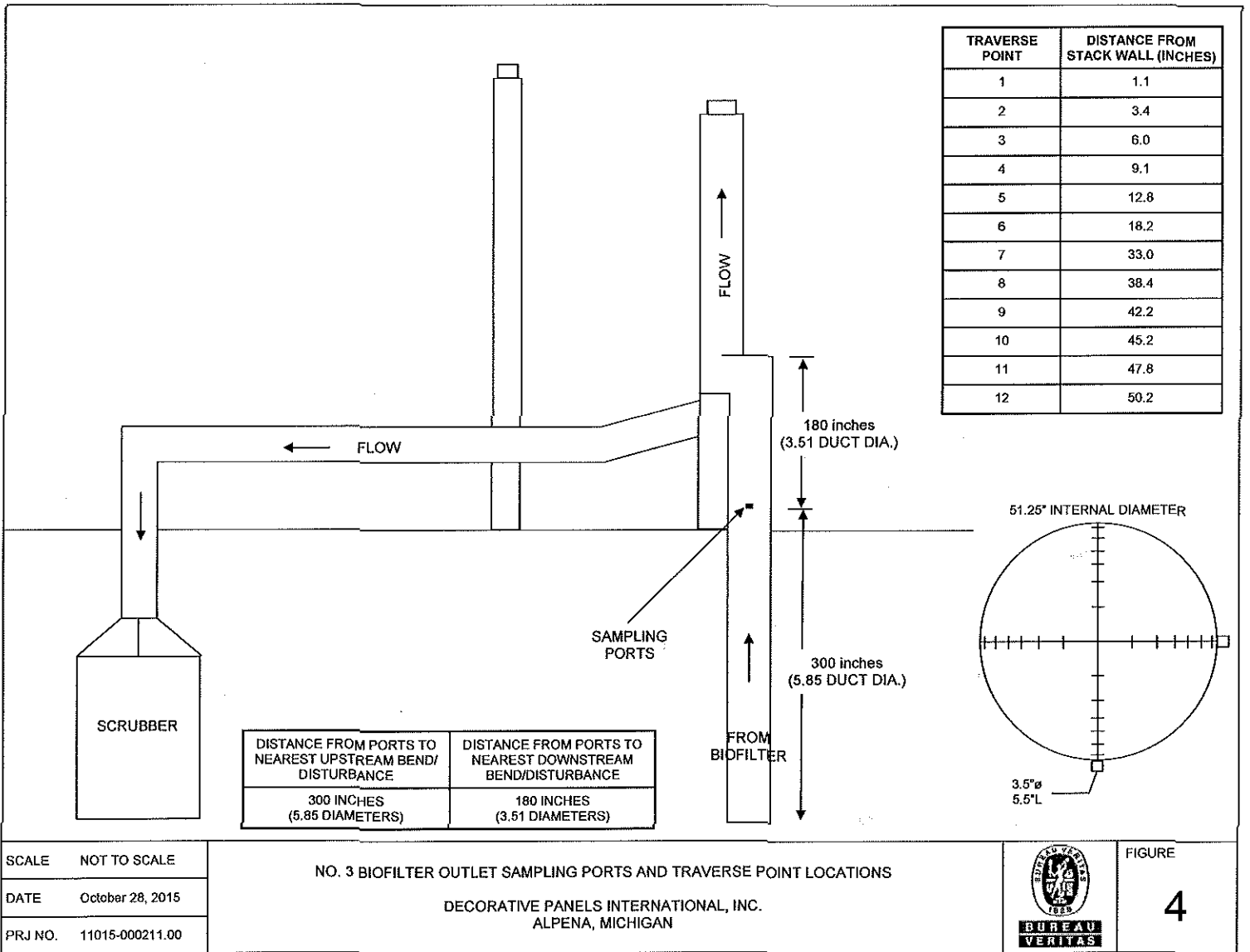

SCALE NOT TO SCALE  
 DATE October 28, 2015  
 PRJ NO. 11015-000211.00

NO. 3 BIOFILTER OUTLET SAMPLING PORTS AND TRAVERSE POINT LOCATIONS  
 DECORATIVE PANELS INTERNATIONAL, INC.  
 ALPENA, MICHIGAN



FIGURE

4



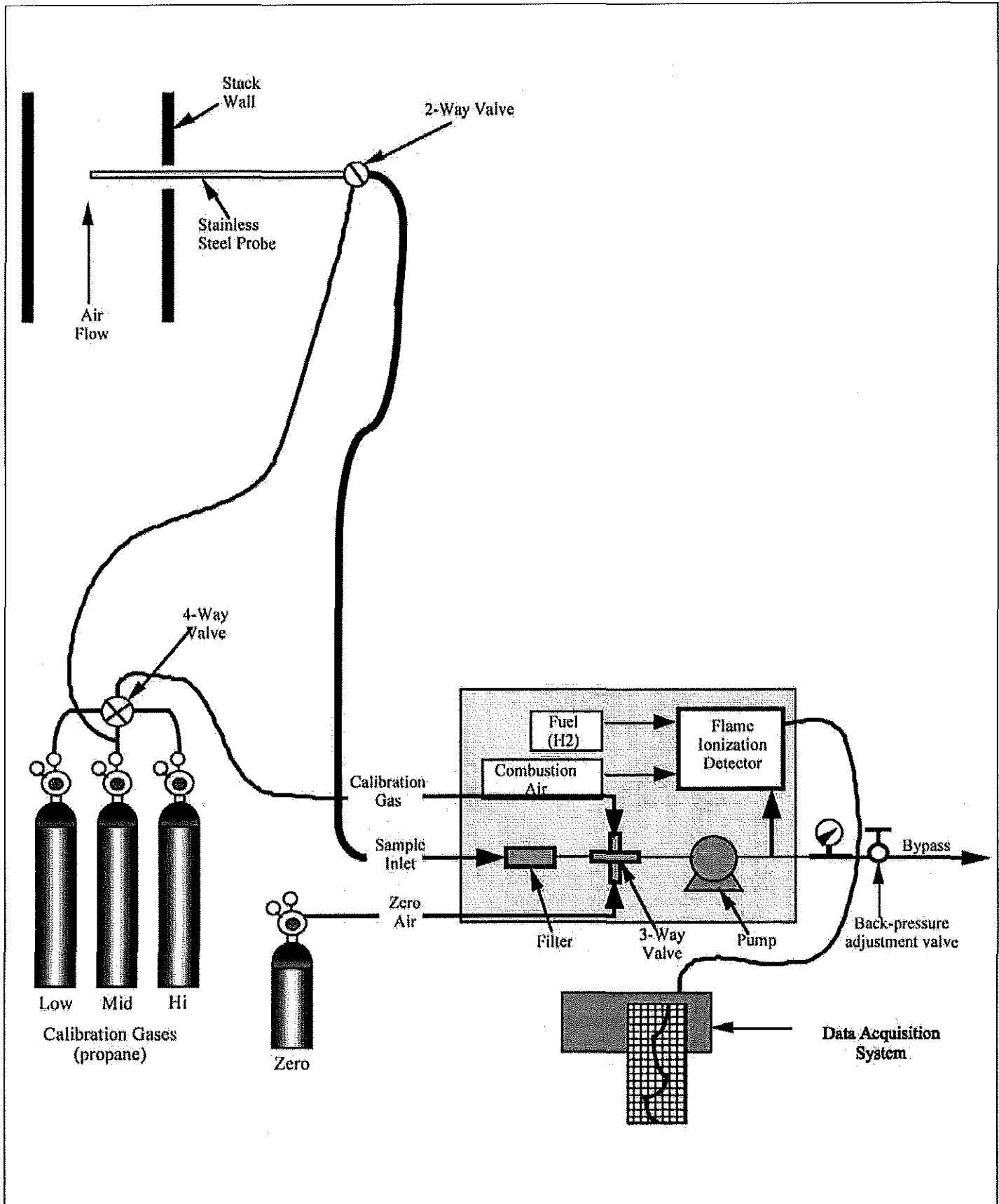

Figure 5  
USEPA Method 25A Sampling  
Train



BUREAU  
VERITAS

DECORATIVE PANELS INTERNATIONAL, INC.  
ALPENA, MICHIGAN

Project No. 11015-000211.00

Last Revision:  
October 28, 2015

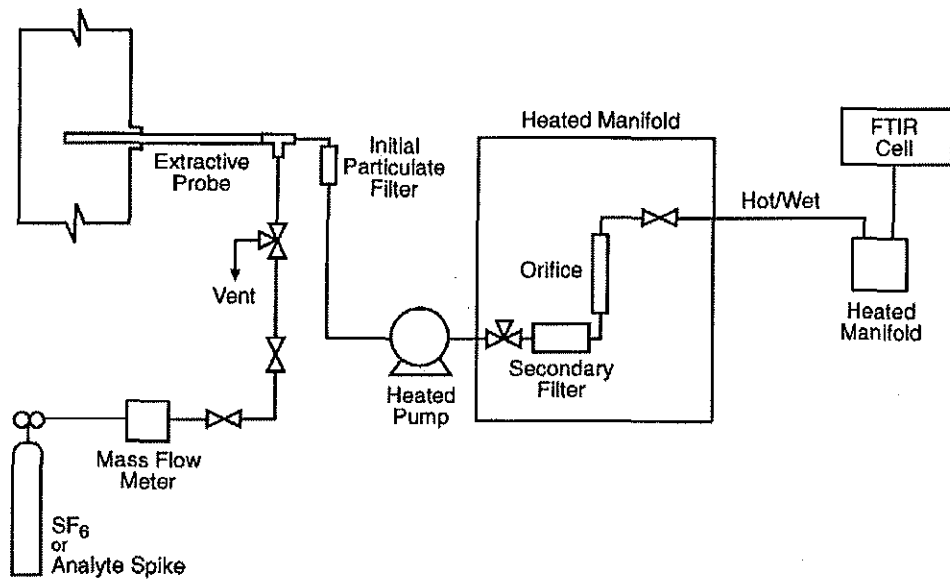

Figure 6  
USEPA Method 320 Sampling Train



DECORATIVE PANELS INTERNATIONAL, INC.  
ALPENA, MICHIGAN

Project No. 11015-000211.00

Last Revision:  
October 28, 2015