

Air Emission Test
for
RECEIVED EU-BOILER
SEP 08 2016
AIR QUALITY DIV

Genesee Power Station
Limited Partnership
G-5310 North Dort Highway

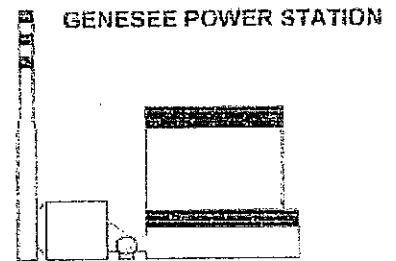

Renewable Operating Permit N3570-2012
State Registration No. N3570

Prepared for
Genesee Power Station, Limited Partnership
Flint, Michigan

Bureau Veritas Project No. 11016-000080.00
July 9, 2016



BUREAU
VERITAS

Move Forward with Confidence

Bureau Veritas North America, Inc.
22345 Roethel Drive
Novi, Michigan 48375
248.344.1770
www.us.bureauveritas.com/hse



Executive Summary

Genesee Power Station, Limited Partnership (Genesee Power) retained Bureau Veritas North America, Inc. to perform air emissions testing at the Genesee Power renewable energy power plant in Flint, Michigan. Air emissions from the boiler exhaust (Emission Unit ID: EU-BOILER) were tested from exhaust stack SVBOILER. Genesee Power provides electricity to the Midwest Independent Transmission Operator (MISO) wholesale electricity market for distribution to the City of Flint and surrounding communities. Genesee Power can produce up to approximately 35 megawatt-hours of electricity.

The purpose of the testing was to:

- Measure hydrogen chloride (HCl), mercury (Hg), and filterable particulate matter (PM) concentrations and mass emission rates.
- Evaluate compliance with (1) Michigan Department of Environmental Quality (MDEQ) Renewable Operating Permit (ROP) MI-ROP-N3570-2012, dated August 24, 2012, and (2) 40 CFR Part 63, Subpart DDDDD, "National Emission Standards for Hazardous Air Pollution for Major Sources: Industrial, Commercial, and Institutional Boilers and Process Heaters."

The testing followed United States Environmental Protection Agency (USEPA) Reference Methods 1, 2, 3A, 4, 5, 19, 26A, 29. Three 120-minute test runs were completed to measure PM and Hg concentrations and mass emission rates, and three 60-minute test runs were completed to measure HCl concentrations and mass emission rates.

Detailed results are presented in Tables 1 and 2 after the Tables Tab of this report. The following table summarizes the results of the testing conducted on May 18 and 19, 2016.



EU-BOILER Air Emissions Test Results

Parameter	Units	Run 1	Run 2	Run 3	Average Result	Permit Limit	40 CFR Part 63 Subpart DDDDD Emission Limits
Filterable Particulate Matter (PM)	lb/hr	0.79	0.55	0.71	0.68	15.7	—
	lb/MMBtu	0.0016	0.0010	0.0013	0.0013	0.03	0.037
Mercury (Hg)	lb/hr	0.00015	0.00016	0.00014	0.00015	0.0047	—
	lb/MMBtu	2.9×10^{-7}	3.0×10^{-7}	2.6×10^{-7}	2.8×10^{-7}	9×10^{-6}	5.7×10^{-6}
Hydrogen Chloride (HCl)	lb/hr	8.6	6.5	7.4	7.5	47.1	—
	lb/MMBtu	0.015	0.011	0.013	0.013	0.09	0.022

lb/hr: pound per hour

lb/MMBtu: pound per million British thermal unit

The results of the testing indicate compliance with the applicable EU-BOILER permit limits listed in the table.



1.0 Introduction

1.1 Summary of Test Program

Genesee Power Station, Limited Partnership retained Bureau Veritas North America, Inc. to perform air emissions testing at the Genesee Power renewable energy plant in Flint, Michigan. Air emissions from the boiler exhaust (Emission Unit ID: EU-BOILER) were tested at the exhaust stack SVBOILER. Genesee Power provides electricity to the Midwest Independent Transmission Operator (MISO) wholesale electricity market for distribution to the City of Flint and surrounding communities. Genesee Power can produce up to approximately 35 megawatt-hours of electricity.

The purpose of the testing was to:

- Measure hydrogen chloride (HCl), mercury (Hg), and filterable particulate matter (PM) concentrations and mass emission rates.
- Evaluate compliance with (1) Michigan Department of Environmental Quality (MDEQ) Renewable Operating Permit (ROP) MI-ROP-N3570-2012, dated August 24, 2012, and (2) 40 CFR Part 63, Subpart DDDDD, "National Emission Standards for Hazardous Air Pollution for Major Sources: Industrial, Commercial, and Institutional Boilers and Process Heaters."

The air emission testing was conducted May 18 and 19, 2016, as described in the Intent-to-Test plan, which was submitted to MDEQ on March 30, 2016, and approved on May 3, 2016. The testing is summarized in Table 1-1.

**Table 1-1
Source Tested, Parameters, and Test Dates**

Source	Parameter	Test Date
EU-BOILER Exhaust	Mercury (Hg)	May 18, 2016
	Filterable Particulate Matter (PM)	May 18, 2016
	Hydrogen Chloride (HCl)	May 18 and 19, 2016



1.2 Key Personnel

Key personnel involved in this test program are listed in Table 1-2. Mr. Kenneth A. DesJardins, General Manager, and Mr. Mitchell Hefner, Environmental Health and Safety Technician, with Genesee Power, provided process coordination and arranged for facility operating parameters to be recorded. The testing was witnessed by Ms. Julie Brunner, Senior Environmental Engineer, and Mr. David Patterson, Environmental Quality Analyst, with MDEQ.

**Table 1-2
Key Personnel**

Genesee Power	Bureau Veritas North America, Inc.
<p>Kenneth A. DesJardins General Manager Genesee Power Station, Limited Partnership 5315 Energy Drive Flint, Michigan 48505 Telephone: 810.785.4144 x2222 Facsimile: 810.785.7836 ken.desjardins@cmsenergy.com</p> <p>Mitchell R. Hefner Environmental Health and Safety Technician Genesee Power Station, Limited Partnership G-5310 North Dort Highway Flint, Michigan 48505 Telephone: 810.785.4144 x 224 Facsimile: 810.785.7836 michell.hefner@cmsenergy.com</p>	<p>Thomas R. Schmelter, QSTI Senior Project Manager Bureau Veritas North America, Inc. 22345 Roethel Drive Novi, Michigan 48375 Telephone: 248.344.3003 Facsimile: 248.344.2656 thomas.schmelter@us.bureauveritas.com</p> <p>Brian P. Young Senior Project Manager Bureau Veritas North America, Inc. 22345 Roethel Drive Novi, Michigan 48375-4710 Telephone: 248.344.7983 Facsimile: 248.344.2656 brian.young@us.bureauveritas.com</p>
Michigan Department of Environmental Quality	
<p>David Patterson Environmental Quality Analyst Michigan Department of Environmental Quality Air Quality Division—Technical Programs Unit Constitution Hall 2nd Floor South Tower 525 West Allegan Street Lansing, Michigan 48909 Telephone: 517.284.6782 Facsimile: 517.355.3122 Pattersond2@michigan.gov</p>	<p>Julie Brunner Senior Environmental Engineer Michigan Department of Environmental Quality Air Quality Division—Technical Programs Unit Constitution Hall 2nd Floor South Tower 525 West Allegan Street Lansing, Michigan, 48909 Telephone: 517.284.6789 Facsimile: 517.335.3122 Brunnerjl@michigan.gov</p>

2.0 Source and Sampling Locations

2.1 Process Description

Genesee Power operates a renewable energy power plant that can produce approximately 35 megawatts of electricity using (1) an ABB Combustion Engineering VU-40 traveling-grate-spreader-stoker boiler rated at 523 million British thermal units per hour (MMBtu/hr) and (2) an ABB single-flow condensing turbine coupled to an ABB synchronous generator unit. The power plant has been in operation since 1995 and is permitted to fire wood biomass, tire derived fuel (up to 20 tons per day), and natural gas for startup.

During testing, the boiler was fired with wood biomass. Tire derived fuel was not used during the test. Based on fuel testing firing all biomass is the worst-case fuel for hydrogen chloride emissions.

The wood biomass is transported to the Genesee Power station via trucks and unloaded into the 7-acre wood yard using a truck dipper (Figure 2-1). The wood biomass is stored in piles that are rotated using front-end loaders to prevent decay, achieve uniform moisture content, and prevent pile fires. Once the wood has achieved the desired characteristics, front-end loaders load wood into a hopper that conveys the wood to the boiler feeders.

Wood is gravity-fed into the feeders and introduced into the boiler at injection points. As the wood and air enter the boiler, the wood rapidly ignites and is combusted, producing heat.

The heat generated increases the temperature of water-filled tubes inside the boiler and produces steam. The steam in the tubes rises and enters a boiler steam drum, where liquid water and vapor are separated. The liquid in the boiler drum is recycled into the boiler tubes for re-heating, while the steam from the drum is sent through tubes positioned in the location of the boiler with the highest temperature for superheating. The high-pressure, superheated steam rotates a turning gear for a turbine-generator unit to generate electricity. After propelling the turning gear, the steam is (1) directed into the boiler or (2) passed through a condenser to be recaptured as liquid and recycled into the boiler.



Figure 2-1. Wood biomass unloading



The ash from the combustion of wood biomass falls to the bottom of the boiler onto a sloped grate. The sloped grate vibrates at set intervals to migrate the ash into a water trough. A screw conveyer moves the ash from the water trough into a storage bin; the ash is sold and/or recycled as fertilizer, concrete mix aggregate, or other applications.

The boiler combustion air (flue gas) that is used to heat the boiler tubes, the boiler drum, and superheater is ducted through an economizer, which pre-heats new boiler feed water that is continually added to the system. The flue gas is also used to pre-heat combustion air (blown in with the wood biomass) prior to being ducted into a mechanical multi-clone separator and electrostatic precipitator (ESP).

The electricity production rate estimated during testing is presented in Table 2-1.

**Table 2-1
Electrical Generation During
Testing**

Run	Electricity Generation (megawatt)
Methods 5 and 29	
1	35
2	35
3	35
Method 26A	
1	35
2	35
3	35
Average	35

RECEIVED
SEP 08 2016
AIR QUALITY DIV.

Genesee Power personnel recorded operating parameters during the emission testing. The recorded operating parameters provided to Bureau Veritas are included in Appendix F.

2.2 Control Equipment

A selective non-catalytic reduction (SNCR) system is used to reduce nitrogen oxide emissions. The SNCR system injects a mist of blended urea and water into the upper sections of the boiler furnace to reduce nitrogen oxide emissions to nitrogen, carbon dioxide, and water. As the flue gas exits the furnace, particles are captured in a series of multi-cyclones.

Cyclones use centrifugal force to remove particles from the gas stream. Particles enter at a high velocity and travel along the cyclone body where the centrifugal force and gravity cause the particles to travel down tapered walls and into a hopper at the bottom. The treated gas exits a tube at the top of the cyclone. Multi-cyclones are used in series to improve particle collection efficiency. Additional particulate matter removal occurs in the ESP (Figure 2-2).

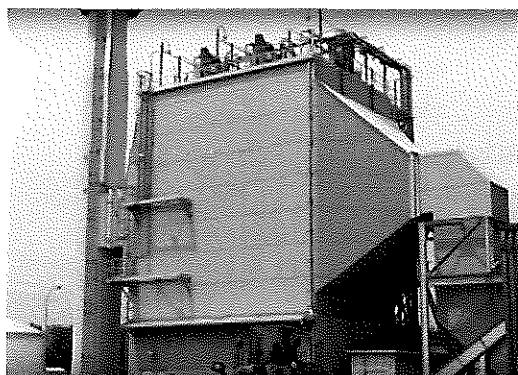

Figure 2-2. ESP

The ESP applies a voltage to generate an electrostatic charge on rows of vertically hung collection plates, which attract particulate matter in the flue. By removing the charge from the collection plates and using a series of plate rappers, the particulate matter is released from the plates and collected at the bottom of the ESP in a hopper. The collected fly ash is pneumatically conveyed to a storage bin; the ash is sold for commercial use (e.g., as a component of concrete). After the air passes through the ESP it is ducted through an induced draft fan that exhaust the flue gas through a 94-inch-diameter, 220-foot-tall stack.

2.3 Operating Parameters

Operating parameters for the wood-waste boiler pollution control equipment are monitored by operators in the control room. Continuous emissions monitoring systems (CEMS) are used to monitor select flue gas exhaust parameters to evaluate permit compliance.

Operating parameters recorded by CEMS for EU-BOILER include the following:

- Opacity (%)
- Oxides of nitrogen, NO_x (ppmvd)
- Flowrate (kscfm = 1,000s of scfm)
- Oxygen, O₂ (% dry)
- Sulfur dioxide, SO₂ (ppmvd)
- Carbon monoxide, CO (ppmvd)

Process data recorded during testing are included in Appendix F.



2.4 Materials Processed During Tests

The facility processes wood biomass. Wood biomass is mixed in the wood yard prior to being combusted in the boiler. Air emissions from the fire of the wood biomass were tested during this study. In addition, Genesee Power personnel collected samples of the wood for analysis.

2.5 Rated Capacity of Process

The boiler is nominally rated at 523 MMBtu/hr and the turbine generator can produce approximately 35 megawatts of electricity—sufficient power for approximately 35,000 homes in Flint and the surrounding Genesee Township.

The power station has the ability to produce approximately 270,000 megawatt-hours annually.

2.6 Flue Gas Sampling Location

Genesee Power provides electricity to the wholesale market for distribution to the City of Flint and surrounding communities. A description of the source tested is presented in Table 2-3.

**Table 2-2
Emission Unit Identification**

Emission Unit ID	Emission Unit Description	Stack Identification
EU-BOILER	35-MW electric generation group consists of the wood waste boiler, a selective non-catalytic reduction (SNCR) system, a mechanical multi-clone separator (MMS), and an electrostatic precipitator (ESP). The boiler has a spreader-stoker design and is rated at 523 MMBtu/hr, and able to produce 345,000 pounds of steam per hour.	SVBOILER

A description of the flue gas sampling location is presented in Section 2.6.1.



2.6.1 EU-BOILER Exhaust

The EU-BOILER exhaust stack is 94 inches in diameter and has four 6.5-inch-diameter sampling ports. Only two ports (located 90° apart) were necessary to conduct the testing. Twelve traverse points for each of the two sampling ports were used to measure stack gas velocity, pollutant concentrations, and mass emission rates. The ports are located:

- Approximately 158 feet (20 duct diameters) from the nearest downstream disturbance (exhaust to atmosphere).
- Approximately 48 feet (6 duct diameters) from the nearest upstream disturbance (duct confluence where flue gas enters exhaust stack).

The sampling ports are accessible via a ladder and a platform on the stack.

Figures 2-3 presents an aerial photograph of the EU-BOILER exhaust stack at Genesee Power facility. Figure 2-4 is a photograph of the EU-BOILER exhaust sampling location. Figure 1 in the Appendix depicts the EU-BOILER sampling and traverse point locations.

Figure 2-3. Aerial Photograph of EU-BOILER Exhaust Stack

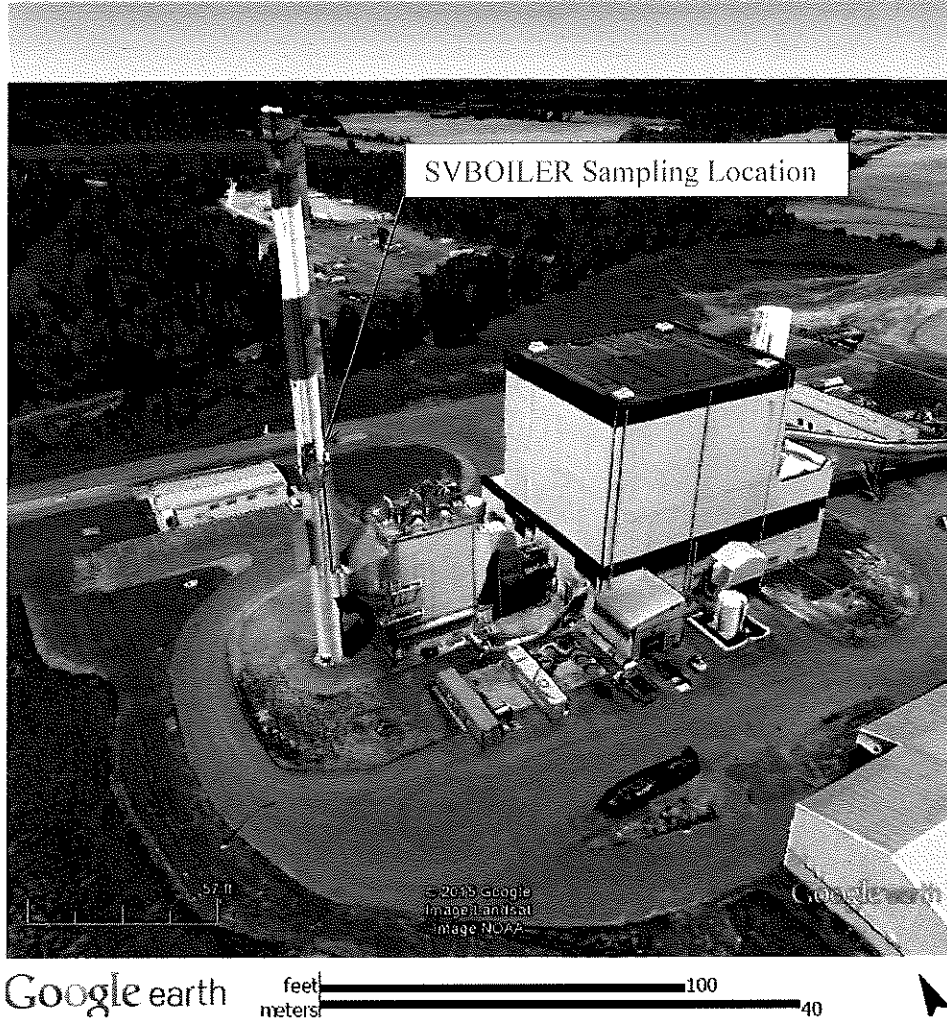
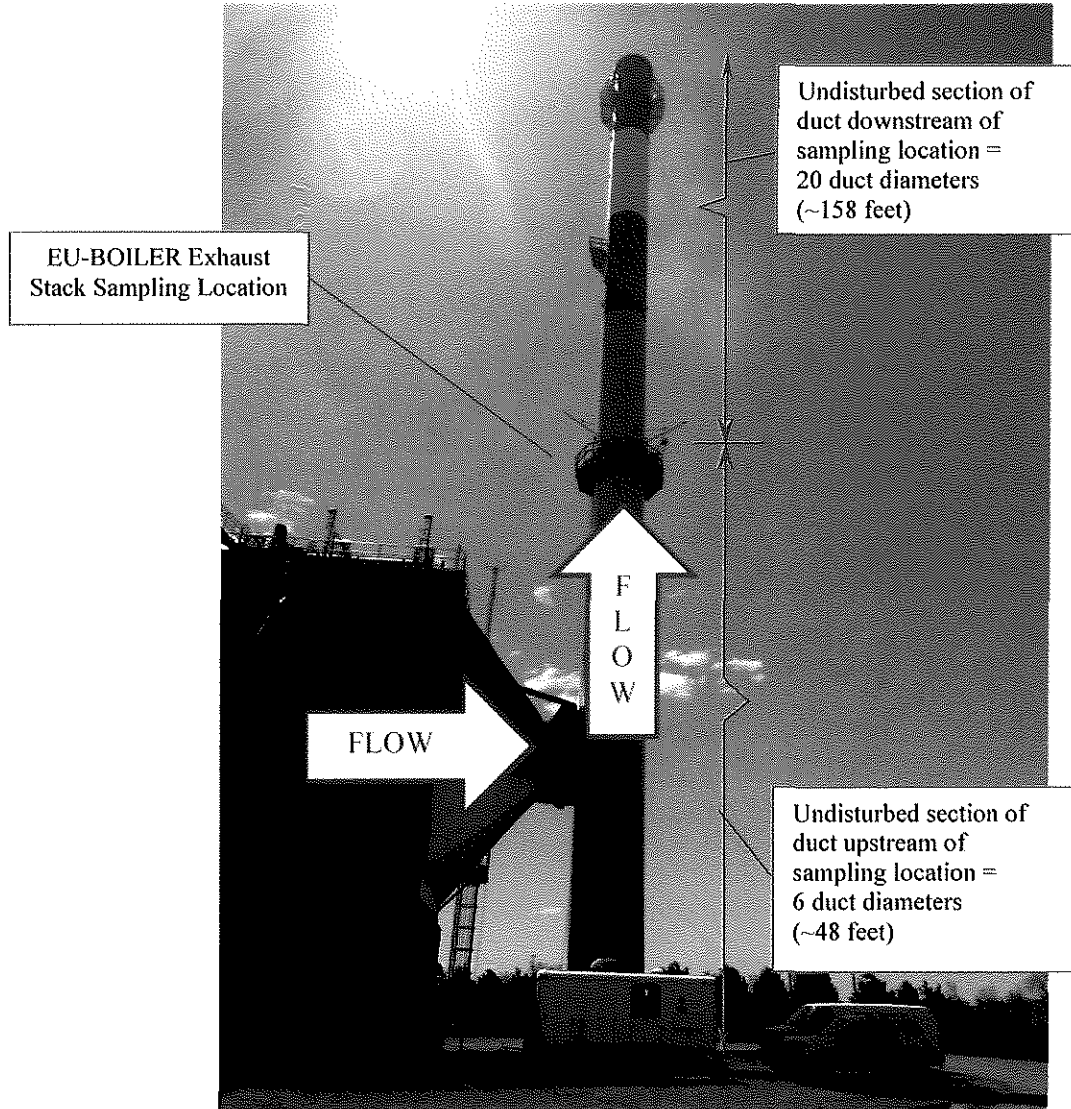

Figure 2-4. EU-BOILER Photograph





3.0 Summary and Discussion of Results

3.1 Objective and Test Matrix

The objective of the testing was to evaluate compliance with applicable emission limits in MDEQ ROP MI-ROP-N3570-2012, dated August 24, 2012, and 40 CFR Part 63, Subpart DDDDD, “National Emission Standards for Hazardous Air Pollutants for Major Sources: Industrial, Commercial, and Institutional Boilers and Process Heaters.”

Table 3-1 summarizes the sampling and analytical matrix.

**Table 3-1
Test Matrix**

Sampling Location	Test Date (2016)	Test Run	Start Time	Stop Time	Sample/ Type of Pollutant	Sampling Method	No. of Test Runs and Duration	Analytical Method	Analytical Laboratory
EU-BOILER Exhaust	May 18	Method 29							
		1	8:00	10:10	Sample location, volumetric flowrate, molecular weight, PM, Hg	1, 2, 3A, 4, 5, 19, and 29	Three 120-minute test runs	Field measurement; Instrument paramagnetic analysis; gravimetric; cold vapor atomic absorption; inductively coupled plasma mass spectrometry	Maxxam Analytics
		2	10:55	13:10					
	3	13:45	15:50						
	Method 26A								
	May 19	1	16:40	17:45	Sample location, volumetric flowrate, molecular weight, HCl	1, 2, 3A, 4, 19, and 26A	Three 60-minute test runs	Field measurement; Instrument paramagnetic and infrared analysis; gravimetric; ion chromatography	Maxxam Analytics
2		8:00	9:05						
3		9:40	10:45						



3.2 Field Test Changes and Issues

3.2.1 CEMs Data

Bureau Veritas measured O₂ and CO₂ concentrations following USEPA Method 3A guidelines. The analyzer calibration error and system bias tests, performed prior to testing, passed the applicable acceptance criteria; however, the O₂ and CO₂ concentrations measured during Test Runs 1 and 2 for Method 29 were observed to be different than those measured by the facility's continuous emissions monitoring system (CEMS). The Genesee Power CEMS is audited for accuracy through analyzer calibration checks and relative accuracy test audits (RATA). Because the O₂ concentrations measured by Bureau Veritas were greater than the CEMS, a leak in the sampling system was suspected.

Bureau Veritas inspected the sampling system and discovered that a quick connect fitting at the junction between the heated sample line and the sample probe malfunctioned causing ambient air to be drawn into the sample line.

The quick connect fitting was replaced and the measured O₂ and CO₂ measurements agreed with the facility CEMS during Run 2 for Method 29. The facility's CEMS O₂ concentrations and the CO₂ measurement for Run 3 were used in emissions calculations for Method 29 Test Runs 1 and 2; Bureau Veritas measurements were used for Run 3 and subsequent tests.

3.3 Results

The results of the testing, compared to the applicable emission limits, are summarized in Table 3-2. Detailed results are presented in Tables 1 and 2 after the Table Tab of this report. Sample calculations are presented in Appendix B.



**Table 3-2
Summary of EU-BOILER Air Emission Test Results**

Parameter	Units	Run 1	Run 2	Run 3	Average Result	Permit Limit	40 CFR Part 63 Subpart DDDDD Emission Limits
Filterable Particulate Matter (PM)	lb/hr	0.79	0.55	0.71	0.68	15.7	—
	lb/MMBtu	0.0016	0.0010	0.0013	0.0013	0.03	0.037
Mercury (Hg)	lb/hr	0.00015	0.00016	0.00014	0.00015	0.0047	—
	lb/MMBtu	2.9×10^{-7}	3.0×10^{-7}	2.6×10^{-7}	2.8×10^{-7}	9×10^{-6}	5.7×10^{-6}
Hydrogen Chloride (HCl)	lb/hr	8.6	6.5	7.4	7.5	47.1	—
	lb/MMBtu	0.015	0.011	0.013	0.013	0.09	0.022

lb/hr: pound per hour

lb/MMBtu: pound per million British thermal unit

The results of the testing indicate compliance with the applicable EU-BOILER permit limits listed in the table.



4.0 Sampling and Analytical Procedures

4.1 Test Methods

Bureau Veritas measured emissions in accordance with the procedures specified in the United States Environmental Protection Agency (USEPA) Standards of Performance for New Stationary Sources. Bureau Veritas used methods presented in Table 4-1.

**Table 4-1
Sampling Methods**

Parameter	Source	USEPA Reference	
	Exhaust of EU-BOILER	Method	Title
Sampling ports and traverse points	•	1	Sample and Velocity Traverses for Stationary Sources
Velocity and flowrate	•	2	Determination of Stack Gas Velocity and Volumetric Flow Rate (Type S Pitot Tube)
Oxygen (O ₂), carbon dioxide (CO ₂), molecular weight	•	3A	Determination of Oxygen and Carbon Dioxide Concentrations in Emissions from Stationary Sources (Instrument Analyzer Procedure)
Moisture content	•	4	Determination of Moisture Content in Stack Gases
Filterable PM	•	5	Determination of Particulate Matter Emissions from Stationary Sources
Emission rate in lb/MMBtu	•	19	Determination of Sulfur Dioxide Removal Efficiency, Particulate Matter, Sulfur Dioxide, and Nitrogen Oxide Emission Rates
Hydrogen chloride (HCl)	•	26A	Determination of Hydrogen Halide and Halogen Emissions from Stationary Sources Isokinetic Method
Mercury (Hg)	•	29	Determination of Metals Emissions from Stationary Sources

• Denotes a test parameter to be tested

4.1.1 Volumetric Flowrate (USEPA Methods 1 and 2)

USEPA Method 1, “Sample and Velocity Traverses for Stationary Sources,” from the Code of Federal Regulations, Title 40, Part 60 (40 CFR 60), Appendix A, was used to evaluate the sampling location and the number of traverse points for the measurement of velocity profiles. Figure 1 (see Figures Tab) depicts the sampling location and traverse points. Details of the sampling location and number of traverse points are presented in the Table 4-2.



Table 4-2
Sampling Location and Number of Traverse Points

Sampling Location	Duct Diameter (inch)	Distance from Ports to Upstream Flow Disturbance (diameter)	Distance from Ports to Downstream Flow Disturbances (diameter)	Number of Ports used	Traverse Points per Port	Total Points
EU Boiler Exhaust	94	5	20	2	12	24

Method 2, “Determination of Stack Gas Velocity and Volumetric Flow Rate (Type S Pitot Tube),” was used to measure flue gas velocity and calculate volumetric flowrate. An S-type Pitot tube and thermocouple assembly connected to an oil-filled manometer and thermometer was used. Because the dimensions of Bureau Veritas’ Pitot tube met the requirements outlined in Method 2, Section 10.0, a baseline Pitot tube coefficient of 0.84 (dimensionless) was assigned.

The Pitot tube inspection and calibration sheet is included in Appendix A. Field data sheets are included in Appendix C. Computer-generated field data sheets are included in Appendix D.

4.1.2 Molecular Weight (USEPA Method 3A)

USEPA Method 3A, “Determination of Oxygen and Carbon Dioxide Concentrations in Emissions from Stationary Sources (Instrument Analyzer Procedure),” was used to measure the oxygen (O₂) and carbon dioxide (CO₂) concentrations of the flue gas. These concentrations were measured in order to calculate an emission rate in pounds of pollutant per million British thermal units (lb/MMBtu).

Figure 2 depicts the USEPA Method 3A sampling train.

Sampling for O₂ and CO₂ consists of extracting the flue gas from the stack through:

- A stainless-steel probe.
- Heated Teflon® sample line to prevent condensation.
- A chilled Teflon condenser with peristaltic pump to remove moisture from the sampled gas stream prior to entering the analyzer.
- A Teledyne® paramagnetic O₂ and CO₂ gas analyzer.



Data was recorded at 1-second intervals on a computer equipped with data acquisition software. Recorded concentrations were reported in 1-minute averages over the duration of each test run.

A calibration error check was performed on each analyzer by introducing zero-, mid-, and high-level calibration gases directly into the analyzer. The calibration error check was performed to evaluate if the analyzers respond to within $\pm 2\%$ of the calibration span. Prior to each test run, a system-bias test was performed where known concentrations of calibration gases are introduced at the probe tip to measure if the response is within $\pm 5\%$ of the analyzer calibration span.

Prior to testing, a three-point stratification test was conducted with the sampling probe located along a traverse line passing through the stack cross section's centroid and at points corresponding to 17, 50, and 83% of the stack diameter. The stack gas was sampled for at least twice the response time. If the concentration at each traverse point is no more than (1) $\pm 5\%$ of the mean concentration or (2) $\pm 0.5\%$, whichever is less restrictive, the gas stream can be considered unstratified. Based on the measurements, the gas stream was considered to be unstratified and a single sampling point located near the centroid of the duct was used (all points had a percent difference less than 5%).

At the conclusion of the each test run, an additional system-bias check was performed to evaluate the analyzer drift from pre- and post-test system-bias checks. The acceptable analyzer drift tolerance is $\pm 3\%$ of the calibration span.

Calibration data along with the USEPA Protocol 1 certification sheets for the calibration gases used are included in Appendix A.

Concentrations of oxygen in the exhaust gas were also measured by the facility's CEMS and averaged over the test periods in order to calculate an emission rate in pounds of HCl per million British thermal unit (lb/MMBtu), if necessary (refer to Section 3.2 for details).

4.1.3 Moisture Content (USEPA Method 4)

Prior to testing, the moisture content was estimated using measurements from previous testing, psychrometric charts, and/or water saturation vapor pressure tables. These data was used in conjunction with preliminary velocity head pressure and temperature data to calculate flue gas velocity, nozzle diameter, and to establish the isokinetic sampling rate for the USEPA Method 5, 26A, and 29 sampling. For each sampling run, moisture content of the flue gases was measured using the reference method outlined in Section 2 of USEPA Method 4, "Determination of Moisture Content in Stack Gases" in conjunction with the performance of USEPA Methods 5, 26A, and 29.



4.1.4 Particulate Matter (USEPA Methods 5 and 29)

USEPA Method 5, “Determination of Particulate Matter Emissions from Stationary Sources,” and Method 29, “Determination of Metals Emissions from Stationary Sources,” were used to measure particulate matter and metals (arsenic, beryllium, cadmium, total chromium, lead, and mercury) emissions. Figure 3 depicts the USEPA Methods 5 and 29 sampling train.

Bureau Veritas’ modular isokinetic stack sampling system consists of:

- A borosilicate glass button-hook nozzle.
- A heated (248±25°F) borosilicate glass-lined probe.
- A desiccated and pre-weighed 110- or 83-millimeter-diameter quartz fiber filter (manufactured to at least 99.95% efficiency (<0.05 % penetration) for 0.3-micron dioctyl phthalate smoke particles) in a heated (248±25°F) filter box.
- A set of six pre-cleaned impingers in an ice bath with the configuration shown in Table 4-3.
- A sampling line.
- An Environmental Supply® control case equipped with a pump, dry-gas meter, and calibrated orifice.

**Table 4-3
USEPA Methods 5 and 29 Impinger Configuration**

Impinger Order (Upstream to Downstream)	Impinger Type	Impinger Contents	Amount
1	Modified	5% HNO ₃ , 10% H ₂ O ₂	100 ml
2	Greenburg-Smith	5% HNO ₃ , 10% H ₂ O ₂	100 ml
3	Modified	Empty	0 ml
4	Modified	Acidified KMnO ₄	100 ml
5	Modified	Acidified KMnO ₄	100 ml
6	Modified	Silica gel desiccant	~200-300 g

Before testing, a preliminary velocity traverse was performed and an ideal nozzle size was calculated. The calculated nozzle size allowed isokinetic sampling at an average rate of 0.75 cfm. Bureau Veritas selected a pre-cleaned borosilicate glass nozzle with an inner diameter that approximates the calculated ideal value. The nozzle inside diameter was measured with calipers



across three cross-sectional chords. The nozzle was rinsed and connected to the borosilicate glass-lined sample probe.

The impact and static pressure openings of the Pitot tube were leak-checked at or above a pressure of 3 inches of water for more than 15 seconds. The sampling train was leak-checked by capping the nozzle tip and applying a vacuum of approximately 15 inches of mercury to the sampling train. The dry-gas meter was monitored to measure whether the sample train leak rate was less than 0.02 cfm. If the pre-test leak failed, the sampling train was adjusted until the leak rate was <0.02 cfm. Next, the sampling probe was inserted into the stack through the sampling port to begin sampling.

Ice and water was placed around the impingers and the probe and filter temperatures were allowed to stabilize at $\geq 248 \pm 25^\circ\text{F}$ before each test run. After the desired operating conditions were coordinated with the facility, testing was initiated.

Stack parameters (e.g., flue velocity, temperature) were monitored to establish the isokinetic sampling rate to within $\pm 10\%$ for the duration of the test.

At the conclusion of a test run and the post-test leak check, the sampling train was disassembled and the impingers and filter were transported to the recovery area. The filter was recovered using Teflon-lined tweezers and placed in a Petri dish. The Petri dish was immediately labeled and sealed with Teflon tape. The nozzle, probe, and the front half of the filter holder assembly was brushed and, at a minimum, triple-rinsed with acetone to recover particulate matter. The acetone rinses were collected in pre-cleaned sample containers.

Next, the probe nozzle, fittings, probe liner, and front-half of the filter holder were washed and brushed (using a nylon bristle brush) three times with 100 ml of 0.1-N nitric acid (HNO_3). This rinsate was collected in a 500-ml glass sample container. Following the HNO_3 rinse, the probe nozzle, fittings, probe liner, and front-half of the filter holder were rinsed with HPLC water followed by acetone. The HPLC water and acetone rinses were discarded.

At the end of a test run, the liquid volume collected in each impinger was measured using a graduated cylinder to within ± 0.5 milliliters; these volumes measurements were used to calculate the moisture content of the flue gas.

The contents of Impingers 1 and 2 were transferred to two glass sample containers. Impingers 1 and 2, the filter support, the back half of the filter housing, and connecting glassware were thoroughly rinsed with 100 ml of 0.1-N HNO_3 , and the rinsates were added to the sample containers in which the contents of the first two impingers were stored.

The weight of the contents of Impinger 3 was measured and the contents transferred to a glass sample container. This impinger was rinsed with 100 ml of 0.1-N HNO_3 , and the rinsate was added to the glass sample container.



The weight of liquid in Impingers 4 and 5 were measured and the contents transferred to a glass sample container. The impingers and connecting glassware were triple-rinsed with acidified KMnO_4 solution and the rinsate was added to the Impinger 4 and 5 sample containers. Subsequently, these impingers were rinsed with 100 ml of HPLC water, and the rinsate was added to the sample container. Because deposits may still be visible on the impinger surfaces after the water rinse, 25 ml of 8-N hydrochloric acid were used to wash these impingers and connecting glassware. This 8-N hydrochloric acid rinsate was collected in a separate sample container containing 200 ml of water.

The silica gel impinger was weighed as part of the measurement of the flue gas moisture content. All sample containers containing the acetone, 0.1- HNO_3 , HPLC water, 5% HNO_3 /10% H_2O_2 , acidified KMnO_4 , 8-N hydrochloric acid, and filter blanks were transported by courier to Maxxam Analytics, a Bureau Veritas laboratory, located in Mississauga, Ontario, Canada for analysis.

4.1.5 Emission Rates (USEPA Method 19)

USEPA Method 19, "Determination of Sulfur Dioxide Removal Efficiency and Particulate Matter, Sulfur Dioxide, and Nitrogen Oxide Emission Rates," was used to calculate an emission rate (lb/MMBtu). Oxygen concentrations and F factors (ratios of combustion gas volumes to heat inputs) were used to calculate emission rates using equation 19-1 from the method:

$$E = C_d F_d \frac{20.9}{(20.9 - \%O_{2d})}$$

Where:

- E = Pollutant emission rate (lb/million Btu)
- C_d = Pollutant concentration, dry basis (lb/dscf)
- F_d = Volumes of combustion components per unit of heat content, (9,240 dscf/million Btu for wood)
- $\%O_{2d}$ = Concentration of oxygen on a dry basis (% , dry)

4.1.6 Hydrogen Chloride (USEPA Method 26A)

USEPA Method 26A, "Determination of Hydrogen Halide and Halogen Emissions from Stationary Sources," was used to measure hydrogen chloride emissions. Three 60-minute test runs were performed at the EU-BOILER sampling location. Figure 4 depicts the USEPA Method 26A sampling train.

Bureau Veritas' modular isokinetic stack sampling system consists of:

- A borosilicate glass button-hook nozzle.



- A heated borosilicate glass-lined probe maintained at a temperature greater than 248°F.
- A desiccated and an untarred 83-millimeter-diameter filter in a filter box maintained at a temperature above 248°F.
- A set of five pre-cleaned impingers with the configuration shown in Table 4-4.
- A sampling line.
- An Environmental Supply® control case equipped with a pump, dry-gas meter, and calibrated orifice.

Table 4-4
Method 26A Impinger Configuration

Impinger Order (Upstream to Downstream)	Impinger Type	Impinger Contents	Amount (gram)
1	Greenburg-Smith	0.1N H ₂ SO ₄	100
2	Greenburg-Smith	0.1N H ₂ SO ₄	100
3	Modified	0.1N NaOH	100
4	Modified	0.1N NaOH	100
5	Modified	Silica gel desiccant	~200-300

Before testing, a preliminary velocity traverse was performed and a nozzle size was calculated that would allow isokinetic sampling at an average rate of 0.75 cfm. Bureau Veritas selected a pre-cleaned borosilicate glass nozzle that had an inner diameter that approximated the calculated ideal value. The nozzle was measured with calipers across three cross-sectional chords to evaluate the inside diameter; rinsed and brushed with Type 3 deionized water and proof-rinsed with 0.1N H₂SO₄; and connected to the borosilicate glass-lined sample probe.

The impact and static pressure openings of the Pitot tube were leak-checked at or above a velocity head of 3.0 inches of water for more than 15 seconds. The sampling train was leak-checked by capping the nozzle tip and applying a vacuum of approximately 15 inches of mercury to the sampling train. The dry-gas meter was monitored for approximately 1 minute to measure that the sample train leakage rate was less than 0.02 cubic foot per minute (cfm). The sample probe was then inserted into the sampling port to begin sampling.

Ice was placed around the impingers and the probe, and filter temperatures were allowed to stabilize to a temperature above 248°F before sampling. After the desired operating conditions were coordinated with the facility, testing was initiated.



Stack parameters (e.g., flue velocity, temperature) were monitored to establish the isokinetic sampling rate within $\pm 10\%$ for the duration of the test. Each of the 12 traverse points were sampled at 2.5-minute intervals.

At the conclusion of a test run and the post-test leak check, the sampling train was disassembled and the impingers and filter housing were transported to the recovery trailer. The filter was removed from the filter housing and discarded. The nozzle and probe liner, and the front half of the filter housing were rinsed with deionized water to remove any existing particulate matter. The deionized water rinses were discarded.

At the end of a test run, the liquid volume collected in each impinger, including the silica gel impinger, was measured using an electronic scale; these volumes were used to calculate the moisture content of the flue gas. The contents of Impingers 1 and 2, back half of the filter housing and connecting glassware were placed in a 500 ml polyethylene bottle with a Teflon cap screw liner. The described glassware was rinsed three times with deionized water and the rinsate was placed in that same sample container. The sample container was labeled as 0.1N H₂SO₄/DI, marked at the liquid level, and sealed.

The volume of the contents of Impinger 4 and 5, and all connecting glassware were emptied into a polyethylene bottle with a Teflon screw cap liner. The described glassware was rinsed three times with deionized water and the rinsate was placed in the same polyethylene bottle. This sample container was labeled as 0.1N NaOH/DI, marked at the liquid level, and sealed.

All sample containers, including blanks of water, 0.1N H₂SO₄, and 0.1N NaOH were sent by courier to Maxxam Analytics, a Bureau Veritas laboratory, located in Mississauga, Ontario, Canada for analysis.

4.2 Procedures for Obtaining Process Data

Process data were recorded by Genesee Power personnel. Refer to Section 2.1 and 2.2 for discussions of process and control device data and Appendix F for the operating parameters recorded during testing.

4.3 Sampling Identification and Custody

Mr. Thomas Schmelter, with Bureau Veritas, was responsible for the handling and procurement of the data collected in the field. Mr. Schmelter ensured the data sheets were accounted for and completed.

Recovery and analytical procedures were applicable to the sampling methods used in this test program. Sampling and recovery procedures were described previously Section 4.0.



Applicable Chain of Custody procedures followed guidelines outlined within ASTM D4840-99 (Reapproved 2010), "Standard Guide for Sample Chain-of-Custody Procedures."

For each sample collected (i.e., impinger, sorbent tube) sample identification and custody procedures were completed as follows:

- Containers were sealed to prevent contamination.
- Containers were labeled with test number, location, and test date.
- Containers were stored in a cooler.
- Samples were logged using guidelines outlined in ASTM D4840-99 (Reapproved 2010), "Standard Guide for Sample Chain-of-Custody Procedures."
- Samples were delivered to the laboratory.

Chains of custody and laboratory analytical results are included in Appendix E.



5.0 QA/QC Activities

Equipment used in this test program passed quality assurance/quality control (QA/QC) procedures. Refer to Appendix A for equipment calibrations and inspection sheets. Field data sheets are presented in Appendix C. Computer-generated data sheets are presented within Appendix D.

5.1 Pretest QA/QC Activities

Before testing, the sampling equipment was cleaned, inspected, and calibrated according to procedures outlined in the applicable USEPA sampling method and USEPA's "Quality Assurance Handbook for Air Pollution Measurement Systems: Volume III, Stationary Source-Specific Methods."

5.2 QA/QC Audits

The results of select sampling and equipment QA/QC audits and the acceptable tolerance are presented in the following sections. Analyzer calibration and gas certification sheets are present in Appendix A.

5.2.1 Sampling Train QA/QC Audits

The sampling train described in Section 4.1 was audited for measurement accuracy and data reliability. Table 5-1 summarizes the QA/QC audits conducted for the Methods 5, 26A, and 29 sampling trains.



**Table 5-1
Methods 26A and 29 Sampling Train QA/QC Audits**

Parameter	Run 1	Run 2	Run 3	Method Requirement	Comment
Method 26A					
Sampling train leak check Post-test	0 ft ³ for 1 min at 7 in Hg	0.010 ft ³ for 1 min at 10 in Hg	0 ft ³ for 1 min at 5 in Hg	<0.020 ft ³ for 1 minute at ≥ sample vacuum recorded during test	Valid
Sampling vacuum (in Hg)	3 to 6	3 to 5	7		
Methods 5 and 29					
Sampling train leak check Post-test	0 ft ³ for 1 min at 12 in Hg	0.005 ft ³ for 1 min at 11 in Hg	0.010 ft ³ for 1 min at 12 in Hg	<0.020 ft ³ for 1 minute at ≥ sample vacuum recorded during test	Valid
Sampling vacuum (in Hg)	4 to 8	3 to 6	3 to 6		

5.2.2 Instrument Analyzer QA/QC Audits

The instrument sampling trains described in Section 4.1 were audited for measurement accuracy and data reliability. The analyzers passed the applicable calibration criteria. Table 5-2 summarizes gas cylinders used during this test program. Refer to Appendix A for additional calibration data.

**Table 5-2
Calibration Gas Cylinder Information**

Parameter	Gas Vendor	Cylinder Serial Number	Cylinder Value	Expiration Date
Carbon dioxide (CO ₂) Oxygen (O ₂) Nitrogen (N)	Airgas	XC018136B	19.94% (CO ₂) 20.09% (O ₂) Balance (N)	2/26/23
		CC307809	11.20% (CO ₂) 10.91% (O ₂) Balance (N)	2/17/23
Nitrogen (N)	Airgas	CC183736	99.9995%	11/2/23



5.2.3 Dry-Gas Meter QA/QC Audits

Table 5-3 summarizes the dry-gas meter calibration checks in comparison to the acceptable USEPA tolerance. Refer to Appendix A for DGM calibrations.

Table 5-3
Dry-gas Meter Calibration QA/QC Audit

Dry-Gas Meter	Pre-test DGM Calibration Factor (Y) (dimensionless)	Post-Test DGM Calibration Factor (Y) (dimensionless)	Difference Between Pre- and Post-test DGM Calibrations	Acceptable Tolerance	Comment
6	0.959 February 18, 2016	0.954 May 27, 2016	0.005	±0.05	Valid

5.2.4 Isokinetic Sampling

Isokinetic sampling, which means collecting flue gas into the sampling nozzle at the velocity equal to that of the flue gas velocity, is a requirement of USEPA Methods 5, 26A, and 29.

Maintaining isokinetic sampling is important because under isokinetic conditions, sample concentrations may be biased depending on the inertial effects of the particles. When flue gas containing small and large particles are collected isokinetically, the small and large particle concentrations are consistent with the flue gas composition. However, in over-isokinetic conditions (200% high sampling flowrate into nozzle), the particulate matter concentrations are biased low, because a greater number of smaller, lighter particles and fewer large, heavier particles will be collected compared to isokinetic conditions. Under-isokinetic sampling (50% low sampling flowrate into nozzle) will bias the results high because a greater number of larger, heavy particles will be collected.

The USEPA Methods 5, 26A, and 29 isokinetic sampling rate for each test run is presented in Table 5-4. The isokinetic sampling rates were within the isokinetic requirement of 100±10% percent.



**Table 5-4
Summary of Isokinetic Sampling Rates**

Source	Sampling Date 2016	Run	Actual % Isokinetic Sampling Rate	Allowable % Isokinetic Sampling Rate
EU-BOILER	Method 26A			100±10
	May 18	1	100	
	May 19	2	99	
		3	93	
	Methods 5 and 29			
	May 18	1	102	
		2	99	
		3	100	

5.2.5 Thermocouple QA/QC Audits

Temperature measured using thermocouples and digital pyrometers were compared to a reference temperature (i.e., ice water bath, boiling water) before and after testing to evaluate accuracy of the equipment. The thermocouples and pyrometers measured temperature within ±1.5% of the reference temperatures and were within USEPA acceptance criteria. Thermocouple calibration sheets are presented in Appendix A.

5.2.6 QA/QC Blanks

Reagent and field blanks were analyzed for particulate matter. The results of the blanks are presented in Table 5-5. Analytes of concern were not detected in the reagent and field blanks.



**Table 5-5
QA/QC Blanks**

Sample Identification	Result	Comment
M5 Filter Blank	<0.30 mg	
M5 Acetone Blank	0.5 mg	Sample Volume 80 ml
M29 Filter Blank	<0.30	
M29 Acetone Blank	<0.5 mg	Sample Volume 100 ml
M26A Acetone Blank	0.7 mg	Sample Volume 83 ml
M29 Blanks	Not detected	Hg not detected in Method 29 blanks
M26A Blanks	Not detected	HCl and Cl not detected in Method 26A blanks

5.3 QA/QC Checks for Data Reduction and Validation

Bureau Veritas validated the computer spreadsheets onsite. The computer spreadsheets were used to evaluate the accuracy of field calculations. The field data sheets were reviewed to evaluate whether data has been recorded appropriately. The computer data sheets were checked against the field data sheets for accuracy during review of the draft report. Sample calculations were performed to check computer spreadsheet computations.

5.4 QA/QC Problems

Equipment audits and QA/QC procedures demonstrate sample collection accuracy for the test runs.



6.0 Limitations

The information and opinions rendered in this report are exclusively for use by Genesee Power Station, Limited Partnership. Bureau Veritas North America, Inc. will not distribute or publish this report without Genesee Power Station, Limited Partnership's consent except as required by law or court order. The information and opinions are given in response to a limited assignment and should be implemented only in light of that assignment. Bureau Veritas North America, Inc. accepts responsibility for the competent performance of its duties in executing the assignment and preparing reports in accordance with the normal standards of the profession, but disclaims any responsibility for consequential damages.

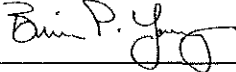
This report prepared by: 

Brian P. Young
Senior Project Manager
Health, Safety, and Environmental Services

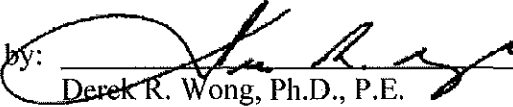
This report approved by: 

Derek R. Wong, Ph.D., P.E.
Director and Vice President
Health, Safety, and Environmental Services



Table 1 - EU-BOILER Exhaust Mercury and Particulate Matter Results

Facility	Genesee Power				
Source Designation	EU-BOILER				
Test Date	May 18, 2016	May 18, 2016	May 18, 2016		
Meter/Nozzle Information	Run 1 - M29	Run 2 - M29	Run 3 - M29	Average	
Meter Temperature, T_m	°F	57	63	70	64
Meter Pressure, P_m	in Hg	30.55	30.59	30.59	30.58
Measured Sample Volume, V_m	ft ³	147.04	152.78	156.96	152.26
Sample Volume, V_m	std ft ³	145.79	149.86	151.96	149.20
Sample Volume, V_m	std m ³	4.13	4.24	4.30	4.23
Condensate Volume, V_c	std ft ³	34.31	33.08	33.41	33.60
Gas Density, ρ	std lb/ft ³	0.0730	0.0733	0.0733	0.0732
Total weight of sampled gas	lb	13.144	13.410	11.458	12.671
Nozzle Size, A_n	ft ²	0.0004958	0.0004958	0.0004958	0.0004958
Isokinetic Variation, I	%	102	100	100	101
Stack Data					
Average Stack Temperature, T_s	°F	366	372	374	371
Molecular Weight Stack Gas-dry, M_d	lb/lb-mole	30.50	30.50	30.50	30.50
Molecular Weight Stack Gas-wet, M_w	lb/lb-mole	28.12	28.24	28.25	28.20
Stack Gas Specific Gravity, G_s		0.97	0.98	0.98	0.97
Percent Moisture, B_{wt}	%	19.05	18.08	18.02	18.38
Water Vapor Volume (fraction)		0.191	0.181	0.180	0.184
Pressure, P_s	in Hg	30.09	30.09	30.09	30.09
Average Stack Velocity, V_s	ft/sec	76.78	80.41	81.63	79.61
Area of Stack	ft ²	48.19	48.19	48.19	48.19
Exhaust Gas Flowrate					
Flowrate	ft ³ /min, actual	222,016	232,507	236,029	230,184
Flowrate	ft ³ /min, standard wet	142,701	148,419	150,268	147,130
Flowrate	ft ³ /min, standard dry	115,516	121,584	123,188	120,096
Flowrate	m ³ /min, standard dry	3,271	3,443	3,488	3,401
Mercury					
Collected Mass					
Mercury	mg	0.0014	0.0015	0.0013	0.0014
Concentration					
Mercury	mg/dscf	0.0000096	0.0000097	0.0000086	0.0000093
Mass Emission Rate					
Mercury	lb/MMBtu	0.0000029	0.0000030	0.0000026	0.0000028
Mercury	lb/hr	0.00015	0.00016	0.00014	0.00015
Particulate Matter					
Collected Mass					
Particulate Matter Acetone Wash	mg	6.4	4.8	4.4	5.2
Particulate Matter Filter	mg	1.10	<0.3	2.20	1.20
Total Filterable Particulate Matter (FPM)	mg	7.5	5.1	6.6	6.4
Concentration					
Particulate Matter (FPM)	mg/dscf	0.051	0.034	0.043	0.043
Particulate Matter (FPM)	grain/dscf	0.00079	0.00053	0.00067	0.00066
Mass Emission Rate					
Particulate Matter (FPM)	lb/MMBtu	0.0016	0.0010	0.0013	0.0013
Particulate Matter (FPM)	lb/hr	0.79	0.55	0.71	0.68



Table 2 - EU-BOILER Exhaust Hydrogen Chloride Results

Facility	Genesee Power EU-BOILER			
Source Designation	May 18, 2016	May 19, 2016	May 19, 2016	
Test Date	Run 1 - M26A	Run 2 - M26A	Run 3 - M26A	Average
Meter/Nozzle Information				
Meter Temperature, T_m	°F	74	54	64
Meter Pressure, P_m	in Hg	30.63	30.70	30.62
Measured Sample Volume, V_m	ft ³	82.74	78.84	80.82
Sample Volume, V_m	std ft ³	79.66	78.98	79.27
Sample Volume, V_m	std m ³	2.26	2.24	2.24
Condensate Volume, V_a	std ft ³	16.92	15.73	18.81
Gas Density, ρ_s	std lb/ft ³	0.0734	0.0735	0.0727
Total weight of sampled gas	lb	7.090	6.960	5.929
Nozzle Size, A_n	ft ²	0.0004958	0.0004958	0.0005412
Isokinetic Variation, I	%	100	99	93
Stack Data				
Average Stack Temperature, T_s	°F	375	368	372
Molecular Weight Stack Gas-dry, M_d	lb/lb-mole	30.46	30.36	30.40
Molecular Weight Stack Gas-wet, M_w	lb/lb-mole	28.28	28.31	28.02
Stack Gas Specific Gravity, G_s		0.98	0.98	0.97
Percent Moisture, $B_{w,s}$	%	17.52	16.61	19.18
Water Vapor Volume (fraction)		0.175	0.166	0.192
Pressure, P_s	in Hg	30.09	30.19	30.09
Average Stack Velocity, V_s	ft/sec	85.21	83.00	85.11
Area of Stack	ft ²	48.19	48.19	48.19
Exhaust Gas Flowrate				
Flowrate	ft ³ /min, actual	246,405	240,008	246,114
Flowrate	ft ³ /min, standard wet	156,679	154,389	156,987
Flowrate	ft ³ /min, standard dry	129,228	128,741	126,882
Flowrate	m ³ /min, standard dry	3,659	3,646	3,593
Hydrogen Chloride				
Collected Mass				
Hydrogen chloride	mg	40	30	35
Concentration				
Hydrogen chloride	mg/dscf	0.50	0.38	0.44
Mass Emission Rate				
Hydrogen chloride	lb/MMBtu	0.015	0.011	0.013
Hydrogen chloride	lb/hr	8.6	6.5	7.4

94 in Internal Diameter

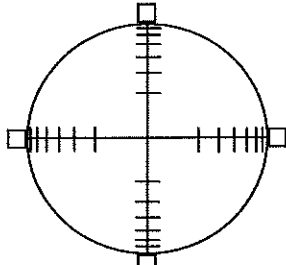

6.5 in σ
12 in L

Traverse Point	Distance from Stack Wall (inch)
1	1.97
2	6.30
3	11.09
4	16.64
5	23.50
6	33.46
7	60.54
8	70.50
9	77.36
10	82.91
11	87.70
12	92.03

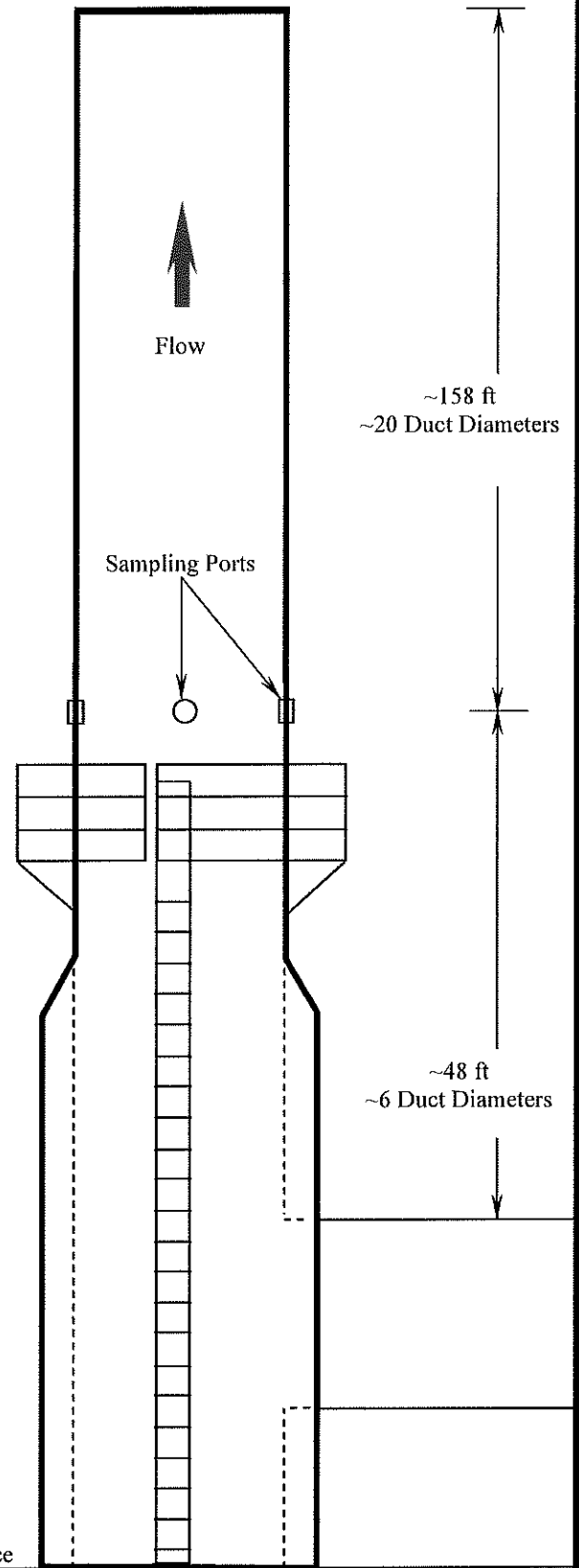

Source	Distance from Ports to Nearest Upstream Disturbance	Distance from Ports to Nearest Downstream Disturbance
EU-Boiler Exhaust Stack	~48 (6 Duct Diameters)	~158 (20 Duct Diameters)

Ground Surface

Not to Scale

May 26, 2016

Project No. 11016-000080.00

EU-BOILER
Sampling Ports and Traverse Point Locations
Genesee Power Station Limited Partnership



Figure

1

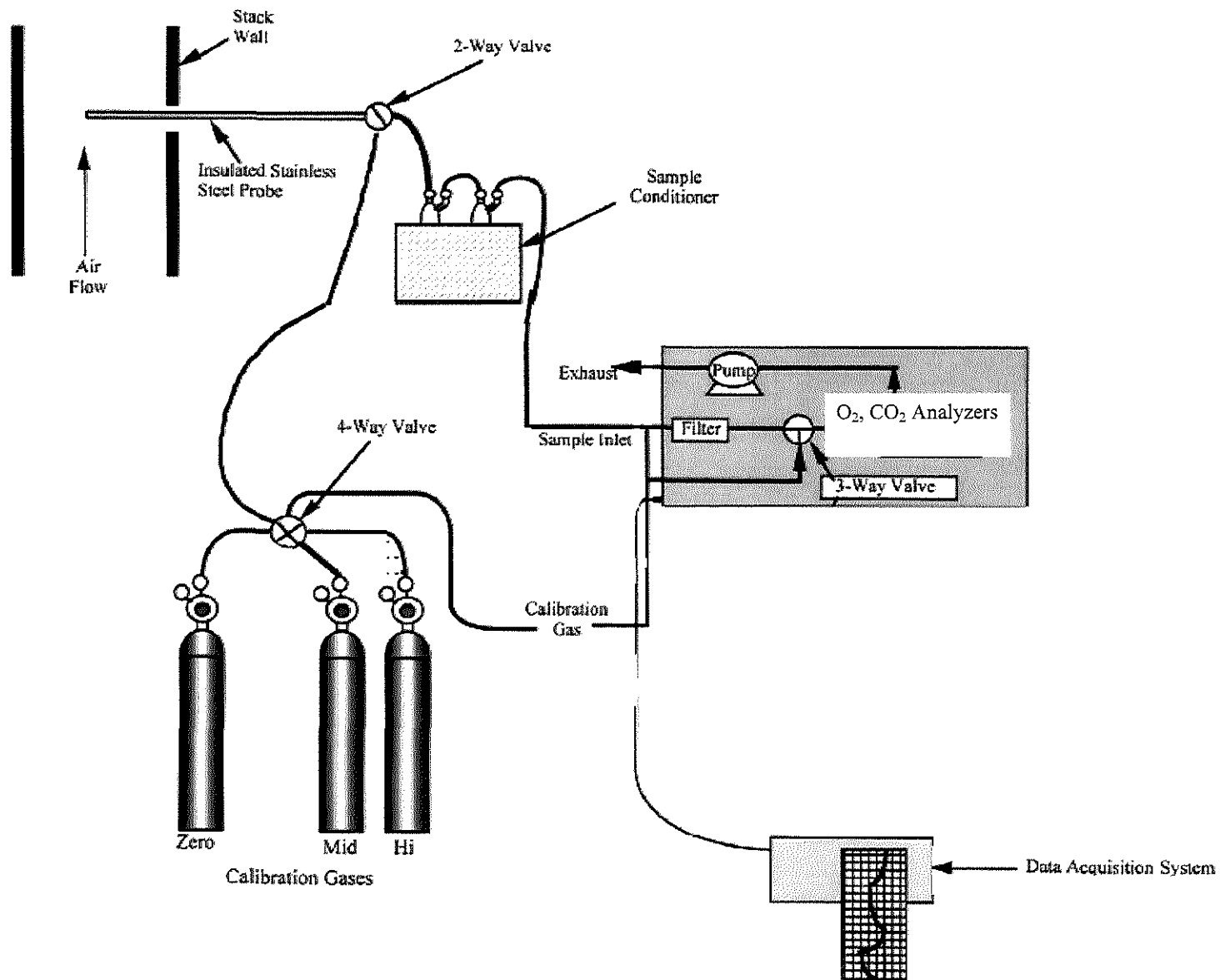

Figure 2
USEPA Method 3A Sampling Train



Genesee Power Station, Limited Partnership
Flint, Michigan

Project No. 11016-000080.00

Last Revision: June 23, 2016

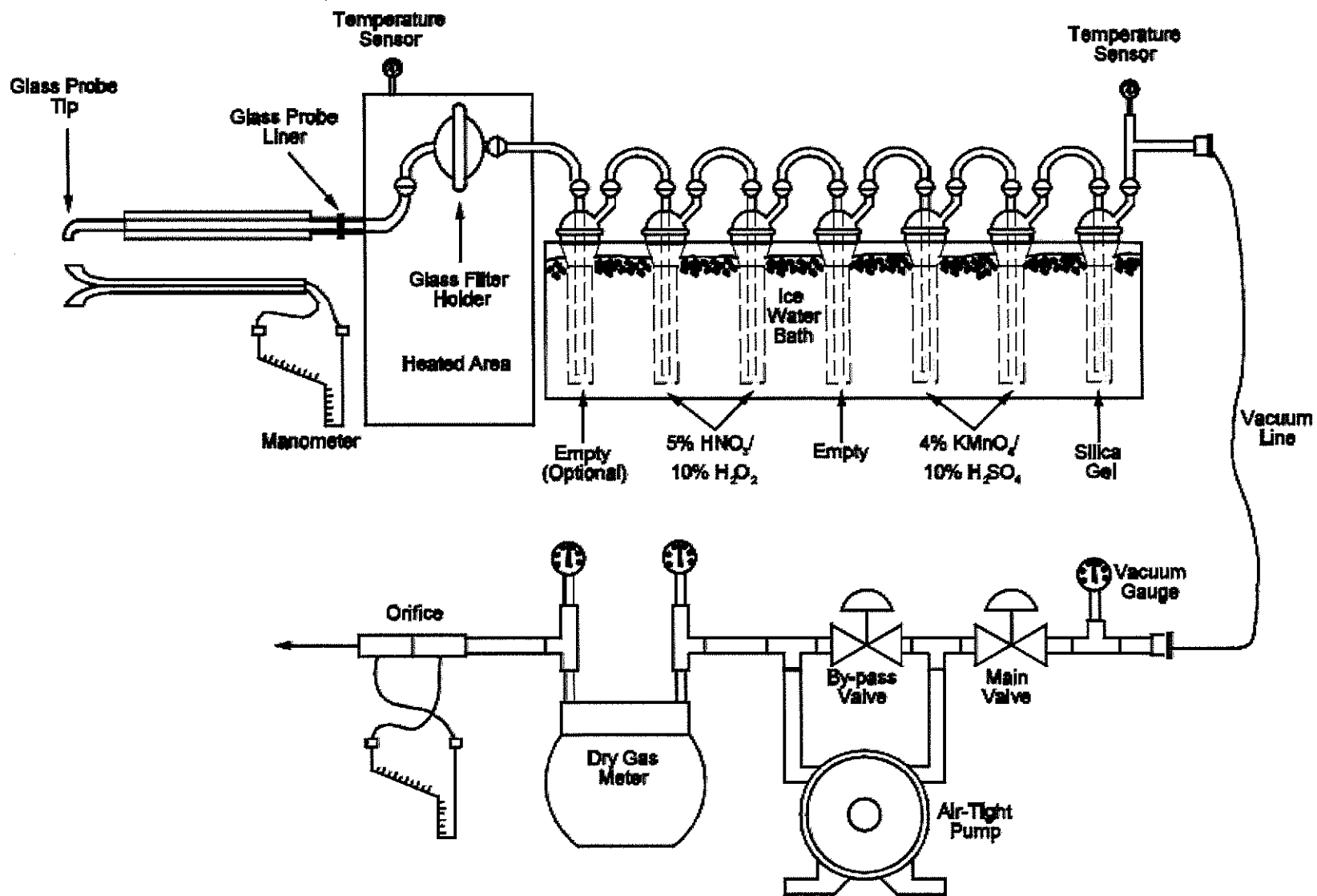

Figure 3
USEPA Methods 5 and 29 Sampling
Train



Genesee Power Station, Limited Partnership
Flint, Michigan

Project No. 11016-000080.00

Last Revision: June 23, 2016

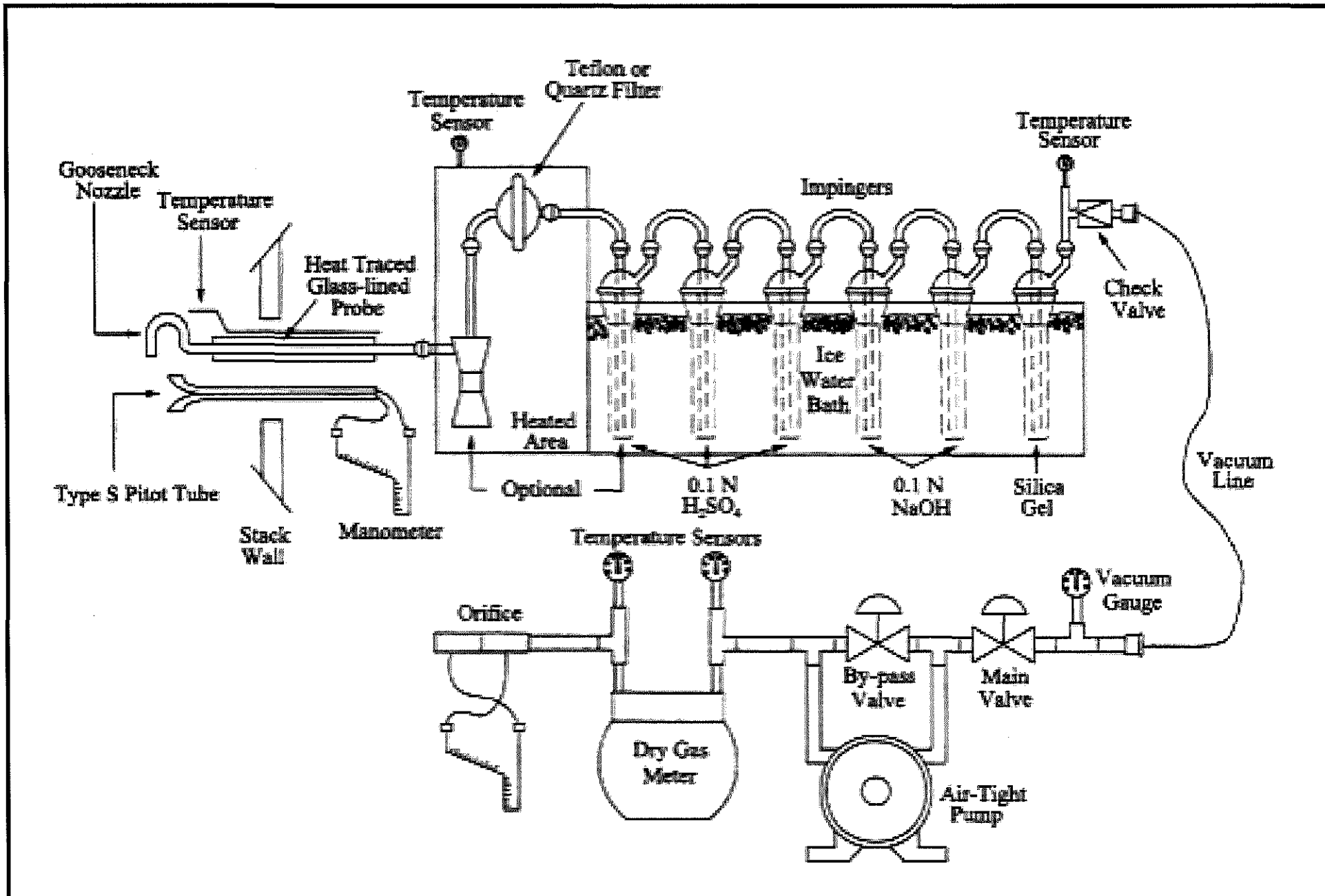

Figure 4
USEPA Method 26A Sampling
Train



BUREAU
VERITAS

Genesee Power Station, Limited Partnership
Flint, Michigan

Project No. 11016-000080.00

Last Revision: June 23, 2016