

**COMPLIANCE TEST REPORT
FOR A
SOURCE SAMPLING PROGRAM
UNDER 40 CFR PART 63, SUBPART ZZZZZ**

**NATIONAL EMISSION STANDARDS FOR HAZARDOUS AIR POLLUTANTS
FROM IRON AND STEEL FOUNDRIES AREA SOURCES**

**EAST JORDAN FOUNDRY, LLC
PTI No. 185-16
State Registration No. N6052**

Test Dates: April 28, 2019 – May 2, 2019

Test Report Date: June 17, 2019

**Prepared for:
Michigan Department of Environmental Quality
And
East Jordan Foundry, LLC**

**Prepared by:
AIR ANALYSIS, LLC
189 Hausman Road
Lenhartsville, PA 19534
Phone (610) 756-3490
Fax (610) 756-3491**

PADEP Laboratory Accreditation No. 06-01087

SUMMARY OF TEST PROGRAM

East Jordan Foundry, LLC (EJF) operates a new gray and ductile iron foundry in Antrim County, Elmira, Michigan. The facility is considered to be a "Large" area source foundry under the rules of 40 CFR Part 63, Subpart ZZZZZ, National Emission Standards for Hazardous Air Pollutants (NESHAP) for Iron and Steel Foundries Area Sources. All Sources at the foundry have been installed and are being operated in accordance with the terms of Michigan Department of Environmental Quality (MDEQ) Permit to Install (PTI) No. 185-16.

The testing program documented in this report was performed for the determination of compliance with air emission limits cited in Subpart ZZZZZ and PTI 185-16 for all applicable sources. Air Analysis, LLC of Lenhartsville, PA was responsible for the performance of the testing program that was completed between April 28, 2019 and May 2, 2019. A total of nine (9) sources were tested while on-site. The test procedures utilized complied with the requirements of the MDEQ and promulgated test methods of Environmental Protection Agency (EPA) 40 CFR 60, Appendices. Representatives of the MDEQ were on-site April 29, 2019 through May 1, 2019 to witness the testing procedures and facility operations.

A Testing Protocol was submitted and subsequently reviewed by the MDEQ, prior to the performance of the testing program. All of the testing was conducted in accordance with the proposed methodology of the protocol, except for Vent ID SVHJ-BH. Test Methods 5 and 202 were originally proposed for this Source, however the preliminary flow traverse resulted in a stack temperature below 85° F. As per Test Method 202, "if the gas filtration temperature never exceeds 30°C (85°F), then use of this method is not required to measure total primary Particulate Matter (PM)". For this reason, Air Analysis, LLC only performed Test Method 17 on this Source for the measurement of Filterable PM.

A few testing and operational issues arose during the program that required changes to the original testing schedule. Air Analysis, LLC was set up to perform the testing of Vent ID's SVC-BH and SVE-BH simultaneously on April 30, 2019. During the preliminary flow traverse conducted on SVC-BH, it was determined that the cyclonic flow angle within the exhaust stack exceed the allowable 20° requirement of Test Method 1. Following discussion with EJF and the MDEQ representative, it was determined that testing would be performed on Vent ID's SVF-BH and SVG-BH that day while the issue on SVC-BH was resolved. Due to the delay however, Air Analysis, LLC was only able to complete two (2) test runs on Vent ID's SVF-BH and SVG-BH before the end of first shift. The final test run on each of these Sources was required to be performed during second shift operations on that same day. Similarly, additional flow traverses were required to be performed on SVC-BH the following day (i.e. May 1, 2019) in order to resolve the cyclonic flow issue, and only two (2) test runs were able to be performed on SVC-BH and SVE-BH during first shift operations. Air Analysis, LLC was again able to conduct the final test run on each of these Sources during second shift operations that same day. The correction of the cyclonic flow issue of SVC-BH was made through changes to the exhaust fan damper position.

Unexpected variations in measured stack gas velocity and the corresponding stack gas volume between the first one-hour test run and the second one-hour test run were noted during the testing of SVD-BH (Baghouse D). Rather than terminate the test at the time, the decision was made to complete the second and third test runs and then review all pertinent information to determine if there was an identifiable explanation for the unexpected variation. Following review of the test results EJF and Air Analysis, LLC have been unable to identify an explanation for the difference in the first one-hour test stack gas volume as well as the substantially different condensable catch weight in comparison to the

2nd and 3rd one-hour test runs. In the absence of an explanation, Air Analysis, LLC considers the results for SVD-BH to be questionable and are noted as such.

During the performance of the gaseous testing, multiple test runs demonstrated minute averages and final emission concentrations as negative values for different parameters. This results when concentrations of zero are measured by the analyzer within the applicable exhaust stack and the initial calibration of the analyzer is biased low. In all cases, analyzer calibrations met with acceptable criteria for cal error, bias and drift, but negative values appear for minute averages and, in some cases, as the final emission result for the test run. For these applicable test runs and as per the MDEQ, the minute averages of each test run printout display the negative value as recorded by the analyzer during the test run. However, if the post test calibration drift test did not correct the measured concentration or value to zero or a positive number, Air Analysis, LLC manually changed the final concentration to zero in their spreadsheet for proper calculation and reporting of emissions. When the final result was changed, a “corrected” notation has been made next to the parameters final result on the test run printout.

Summary tables of the results generated from the testing program are presented in Tables 1 through 10 of this report. As applicable for the purpose of PM result reporting; Test Method 5 results have been compared to the Filterable PM and Filterable PM-10 emission limits, Test Method 17 results have been compared to the Filterable PM and Filterable PM-10 emission limits, combined Test Method 5 and 202 results have been compared to the PM/PM-10/PM-2.5 emission limits and Test Method 202 results have been compared to the PM-2.5 emission limits.

SUMMARY TABLES OF INDIVIDUAL TEST RESULTS

TABLE 2
SUMMARY OF TEST RESULTS
Vent ID SVAB-BH – Particulate Emission Testing

	1	2	3	Averages
Run Number:				
Date:	4/29/2019	4/29/2019	4/29/2019	
Start Time:	7:55	10:15	12:20	
End Time:	8:58	11:18	13:22	
A - Stack Area, SQ.FT:	53.73	53.73	53.73	
CP - Pitot Coefficient:	0.84	0.84	0.84	0.84
Y - Meter Calibration Factor:	0.9824	0.9824	0.9824	0.98
DN - Nozzle Diameter:	0.260	0.260	0.260	0.260
Pbar - Barometric Pressure:	28.81	28.8	28.79	28.80
TT - Sampling Time:	60	60	60	60
VM - Meter Volume:	66.396	67.346	66.123	66.622
VMSTD - Std. Gas Volume (SCF):	65.843	66.472	65.653	65.989
PIT - Avg. Delta P (in. of H2O):	0.784	0.802	0.773	0.786
PM - Avg. Delta H (in. of H2O):	3.829	3.914	3.773	3.84
TS - Stack Temp. (F):	87	88	86	87
TM - Avg. Meter Temp(F):	48	51	47	49
Vlc - Volume Water Collected:	13	15	20	16
VWSTD - Std. Water Volume (SCF):	0.612	0.707	0.942	0.754
%M - Percent Moisture:	0.92	1.05	1.41	1.13
Bws - Mole Fraction, Dry:	0.009	0.011	0.014	0.0113
%CO2 - Carbon Dioxide, Dry:	0.11	0.11	0.11	0.11
%O2 - Oxygen, Dry:	20.88	20.91	20.81	20.87
MD - Dry Molecular Weight:	28.85	28.85	28.85	28.85
MS - Wet Molecular Weight:	28.75	28.74	28.70	28.73
PS - Stack Press. (in. of Hg):	28.77	28.76	28.75	28.76
VS - Stack Gas Velocity (AFPS):	51.7	52.3	51.3	51.77
Qstd - Stack Gas Volume (DSCFM):	153,187	154,540	151,473	153,067
QA - Stack Gas Volume (ACFM):	166,585	168,624	165,458	166,889
QS - Stack Gas Velocity (SCFM):	154,612	156,183	153,647	154,814
%I - Isokinetic Ratio:	104.4	104.5	105.3	104.8
<u>Production Data</u>				
Tons of Metal Melted (Tons/Hr):	25.37	22.59	23.04	23.67
<u>Filterable Particulate Emissions</u>				
Total Filterable PM, mg - Catch weight:	3.20	2.50	2.00	2.57
Emission Concentration, Gr./DSCF:	0.0007	0.0006	0.0005	0.0006
Emission Rate, Lbs./Hr:	0.98	0.77	0.61	0.79
Emission Rate, Lbs./Ton:	0.039	0.034	0.026	0.033
Condensable PM, mg - Catch weight:	9.60	2.90	1.60	4.70
Emission Concentration, Gr./DSCF:	0.0022	0.0007	0.0004	0.0011
Emission Rate, Lbs./Hr:	2.95	0.89	0.49	1.44
Total PM, mg - Catch weight:	12.80	5.40	3.60	7.27
Emission Concentration, Gr./DSCF:	0.0030	0.0013	0.0008	0.0017
Emission Rate, Lbs./Hr:	3.94	1.66	1.10	2.23

TABLE 3
SUMMARY OF TEST RESULTS
Vent ID SVAB-BH –NO_x, SO₂, CO & VOC Emission Testing

	1	2	3	Averages
Run Number:	1	2	3	
Date:	4/29/2019	4/29/2019	4/29/2019	
Start Time:	7:55	10:15	12:20	
End Time:	8:59	11:15	13:20	
TT - Sampling Time:	64	60	60	
%M - Percent Moisture:	0.92	1.05	1.41	1.13
%CO ₂ - Carbon Dioxide, Dry:	0.11	0.11	0.11	0.11
%O ₂ - Oxygen, Dry:	20.88	20.91	20.81	20.87
Qa - Stack Gas Volume (ACFM):	166,585	168,624	165,458	166,889
Qstd - Stack Gas Volume (DSCFM):	153,187	154,540	151,473	153,067
Qstd - Stack Gas Volume (DSCFH):	9,191,248	9,272,412	9,088,410	9,184,023
<u>Production Data</u>				
Tons of Metal Melted (Tons/Hr):	25.37	22.59	23.04	23.67
<u>Emission Results</u>				
NO _x , ppm =	0.36	0.37	0.22	0.32
NO _x , lbs./hr =	0.40	0.41	0.24	0.35
SO ₂ , ppm =	1.03	3.09	1.92	2.01
SO ₂ , lbs./hr =	1.10	3.34	2.03	2.16
CO, ppm =	103.31	102.32	86.12	97.25
CO, lbs./hr =	69.07	69.01	56.93	65.01
CO, lbs./Ton=	2.72	3.05	2.47	2.75
THC, ppm =	8.67	9.95	7.40	8.67
THC, lbs./hr =	9.12	10.56	7.70	9.13
THC, lbs./Ton =	0.36	0.47	0.33	0.39

TABLE 4
SUMMARY OF TEST RESULTS
Vent ID SVC-BH – Particulate Emission Testing

	1	2	3	Averages
Run Number:				
Date:	5/1/2019	5/1/2019	5/1/2019	
Start Time:	11:10	13:55	18:47	
End Time:	12:29	15:13	19:50	
A - Stack Area, SQ.FT:	34.04	34.04	34.04	
CP - Pitot Coefficient:	0.84	0.84	0.84	0.84
Y - Meter Calibration Factor:	1.0050	1.0050	1.0050	1.01
DN - Nozzle Diameter:	0.233	0.233	0.233	0.233
Pbar - Barometric Pressure:	28.6	28.6	28.6	28.60
TT - Sampling Time:	60	60	60	60
VM - Meter Volume:	47.989	47.300	47.646	47.645
VMSTD - Std. Gas Volume (SCF):	44.920	43.935	44.457	44.437
PIT - Avg. Delta P (in. of H2O):	0.634	0.623	0.632	0.629
PM - Avg. Delta H (in. of H2O):	2.007	1.969	1.997	1.99
TS - Stack Temp. (F):	87	83	74	81
TM - Avg. Meter Temp(F):	84	89	86	86
Vlc - Volume Water Collected:	18	16	14	16
VWSTD - Std. Water Volume (SCF):	0.848	0.754	0.659	0.754
%M - Percent Moisture:	1.85	1.69	1.46	1.67
Bws - Mole Fraction, Dry:	0.019	0.017	0.015	0.0167
%CO2 - Carbon Dioxide, Dry:	0.00	0.00	0.00	0.00
%O2 - Oxygen, Dry:	20.62	20.76	20.76	20.71
MD - Dry Molecular Weight:	28.82	28.83	28.83	28.83
MS - Wet Molecular Weight:	28.62	28.65	28.67	28.65
PS - Stack Press. (in. of Hg):	28.56	28.56	28.56	28.56
VS - Stack Gas Velocity (AFPS):	46.6	46.0	45.9	46.15
Qstd - Stack Gas Volume (DSCFM):	86,099	85,689	87,160	86,316
QA - Stack Gas Volume (ACFM):	95,176	93,902	93,715	94,264
QS - Stack Gas Velocity (SCFM):	87,724	87,159	88,452	87,778
%I - Isokinetic Ratio:	100.0	98.3	97.8	98.7
<u>Production Data</u>				
Tons of Metal Melted (Tons/Hr):	20.55	22.32	22.12	21.66
<u>Filterable Particulate Emissions</u>				
Total Filterable PM, mg - Catch weight:	2.30	3.70	3.40	3.13
Emission Concentration, Gr./DSCF:	0.00079	0.0013	0.0012	0.0011
Emission Rate, Lbs./Hr:	0.58	0.95	0.88	0.81
Condensable PM, mg - Catch weight:	2.20	0.00	0.10	0.77
Emission Concentration, Gr./DSCF:	0.0008	0.0000	0.00003	0.00026
Emission Rate, Lbs./Hr:	0.56	0.00	0.03	0.19
Total PM, mg - Catch weight:	4.50	3.70	3.50	3.90
Emission Concentration, Gr./DSCF:	0.00155	0.0013	0.00121	0.0014
Emission Rate, Lbs./Hr:	1.14	0.95	0.91	1.00

TABLE 5
SUMMARY OF TEST RESULTS
Vent ID SVC-BH –NO_x, CO & VOC Emission Testing

	1	2	3	Averages
Run Number:	1	2	3	
Date:	5/1/2019	5/1/2019	5/1/2019	
Start Time:	11:10	13:55	18:47	
End Time:	12:13	15:06	19:47	
TT - Sampling Time:	63	60	60	
%M - Percent Moisture:	1.85	1.69	1.46	1.67
%CO ₂ - Carbon Dioxide, Dry:	0.00	0.00	0.00	0.00
%O ₂ - Oxygen, Dry:	20.62	20.76	20.76	20.71
Qa - Stack Gas Volume (ACFM):	95,176	93,902	93,715	94,264
Qstd - Stack Gas Volume (DSCFM):	86,099	85,689	87,160	86,316
Qstd - Stack Gas Volume (DSCFH):	5,165,913	5,141,337	5,229,571	5,178,940
<u>Production Data</u>				
Tons of Metal Melted (Tons/Hr):	20.55	22.32	22.12	21.66
<u>Emission Results</u>				
NO _x , ppm =	0.00	0.00	0.00	0.00
NO _x , lbs./hr =	0.00	0.00	0.00	0.00
CO, ppm =	15.61	7.99	2.76	8.79
CO, lbs./hr =	5.87	2.99	1.05	3.30
CO, lbs./Ton=	0.29	0.13	0.05	0.16
THC, ppm =	2.45	2.31	1.77	2.18
THC, lbs./hr =	1.45	1.36	1.06	1.29
THC, lbs./Ton =	0.07	0.06	0.05	0.06

TABLE 6
SUMMARY OF TEST RESULTS
Vent ID SVD-BH – Particulate Emission Testing

	1	2	3	Averages
Run Number:				
Date:	4/29/2019	4/29/2019	4/29/2019	
Start Time:	7:55	10:15	12:20	
End Time:	9:06	11:18	13:23	
A - Stack Area, SQ.FT:	25.97	25.97	25.97	
CP - Pitot Coefficient:	0.84	0.84	0.84	0.84
Y - Meter Calibration Factor:	0.9998	0.9998	0.9998	1.00
DN - Nozzle Diameter:	0.213	0.213	0.213	0.213
Pbar - Barometric Pressure:	28.7	28.7	28.7	28.70
TT - Sampling Time:	60	60	60	60
VM - Meter Volume:	46.748	39.460	39.580	41.929
VMSTD - Std. Gas Volume (SCF):	46.805	39.330	39.617	41.917
PIT - Avg. Delta P (in. of H2O):	0.937	0.656	0.664	0.752
PM - Avg. Delta H (in. of H2O):	1.965	1.390	1.395	1.58
TS - Stack Temp. (F):	90	95	97	94
TM - Avg. Meter Temp(F):	48	50	48	48
Vlc - Volume Water Collected:	23	16.5	17	19
VWSTD - Std. Water Volume (SCF):	1.083	0.777	0.801	0.887
%M - Percent Moisture:	2.26	1.94	1.98	2.06
Bws - Mole Fraction, Dry:	0.023	0.019	0.020	0.0206
%CO2 - Carbon Dioxide, Dry:	0.07	0.04	0.08	0.06
%O2 - Oxygen, Dry:	20.73	20.80	20.82	20.78
MD - Dry Molecular Weight:	28.84	28.84	28.85	28.84
MS - Wet Molecular Weight:	28.60	28.63	28.63	28.62
PS - Stack Press. (in. of Hg):	28.66	28.66	28.66	28.66
VS - Stack Gas Velocity (AFPS):	56.9	47.7	48.1	50.91
Qstd - Stack Gas Volume (DSCFM):	79,647	66,499	66,760	70,968
QA - Stack Gas Volume (ACFM):	88,600	74,358	75,015	79,324
QS - Stack Gas Velocity (SCFM):	81,491	67,813	68,109	72,471
%I - Isokinetic Ratio:	102.8	103.5	103.9	103.4
<u>Production Data</u>				
Tons of Metal Melted (Tons/Hr):	25.37	22.59	23.04	23.67
<u>Filterable Particulate Emissions</u>				
Total Filterable PM, mg - Catch weight:	3.70	3.60	2.10	3.13
Emission Concentration, Gr./DSCF:	0.0012	0.0014	0.0008	0.0012
Emission Rate, Lbs./Hr:	0.83	0.80	0.47	0.70
Condensable PM, mg - Catch weight:	18.40	3.60	0.80	7.60
Emission Concentration, Gr./DSCF:	0.0061	0.0014	0.0003	0.0026
Emission Rate, Lbs./Hr:	4.14	0.80	0.18	1.71
Total PM, mg - Catch weight:	22.10	7.20	2.90	10.73
Emission Concentration, Gr./DSCF:	0.0073	0.0028	0.0011	0.0037
Emission Rate, Lbs./Hr:	4.97	1.61	0.65	2.41

TABLE 7
SUMMARY OF TEST RESULTS
Vent ID SVD-BH –NO_x, SO₂, CO & VOC Emission Testing

	1	2	3	Averages
Run Number:	1	2	3	
Date:	4/29/2019	4/29/2019	4/29/2019	
Start Time:	7:55	10:15	12:20	
End Time:	9:01	11:15	13:20	
TT - Sampling Time:	66	60	60	
%M - Percent Moisture:	2.26	1.94	1.98	2.06
%CO ₂ - Carbon Dioxide, Dry:	0.07	0.04	0.08	0.06
%O ₂ - Oxygen, Dry:	20.73	20.80	20.82	20.78
Q _a - Stack Gas Volume (ACFM):	88,600	74,358	75,015	79,324
Q _{std} - Stack Gas Volume (DSCFM):	79,647	66,499	66,760	70,968
Q _{std} - Stack Gas Volume (DSCFH):	4,778,834	3,989,921	4,005,574	4,258,110
<u>Production Data</u>				
Tons of Metal Melted (Tons/Hr):	25.37	22.59	23.04	23.67
<u>Emission Results</u>				
NO _x , ppm =	0.00	0.00	0.00	0.00
NO _x , lbs./hr =	0.00	0.00	0.00	0.00
SO ₂ , ppm =	5.45	3.66	3.90	4.34
SO ₂ , lbs./hr =	3.04	1.70	1.82	2.19
CO, ppm =	55.50	61.95	60.00	59.15
CO, lbs./hr =	19.29	17.98	17.48	18.25
CO, lbs./Ton=	0.76	0.80	0.76	0.77
THC, ppm =	16.76	16.45	14.61	15.94
THC, lbs./hr =	9.17	7.52	6.70	7.80
THC, lbs./Ton =	0.36	0.33	0.29	0.33

TABLE 8
SUMMARY OF TEST RESULTS
Vent ID SVE-BH – Particulate Emission Testing

	1	2	3	Averages
Run Number:	1	2	3	
Date:	5/1/2019	5/1/2019	5/1/2019	
Start Time:	11:10	13:55	9:40	
End Time:	12:30	15:12	10:45	
A - Stack Area, SQ.FT:	18.99	18.99	18.99	
CP - Pitot Coefficient:	0.83	0.83	0.83	0.83
Y - Meter Calibration Factor:	0.9824	0.9824	0.9824	0.98
DN - Nozzle Diameter:	0.216	0.216	0.216	0.216
Pbar - Barometric Pressure:	28.45	28.45	28.61	28.50
TT - Sampling Time:	60	60	60	60
VM - Meter Volume:	55.042	59.512	54.249	56.268
VMSTD - Std. Gas Volume (SCF):	50.003	53.800	49.616	51.140
PIT - Avg. Delta P (in. of H2O):	1.050	1.202	1.055	1.103
PM - Avg. Delta H (in. of H2O):	2.513	2.883	2.531	2.64
TS - Stack Temp. (F):	95	94	88	92
TM - Avg. Meter Temp(F):	86	89	86	87
Vlc - Volume Water Collected:	23	26	23	24
VWSTD - Std. Water Volume (SCF):	1.083	1.225	1.083	1.130
%M - Percent Moisture:	2.12	2.23	2.14	2.16
Bws - Mole Fraction, Dry:	0.021	0.022	0.021	0.0216
%CO2 - Carbon Dioxide, Dry:	0.00	0.00	0.00	0.00
%O2 - Oxygen, Dry:	20.87	20.86	20.93	20.89
MD - Dry Molecular Weight:	28.83	28.83	28.84	28.84
MS - Wet Molecular Weight:	28.61	28.59	28.61	28.60
PS - Stack Press. (in. of Hg):	28.40	28.40	28.58	28.46
VS - Stack Gas Velocity (AFPS):	59.6	64.1	58.5	60.71
Qstd - Stack Gas Volume (DSCFM):	59,967	64,589	59,990	61,515
QA - Stack Gas Volume (ACFM):	67,887	72,979	66,621	69,162
QS - Stack Gas Velocity (SCFM):	61,266	66,059	61,300	62,875
%I - Isokinetic Ratio:	103.7	103.6	102.9	103.4
Production Data				
Tons of Metal Melted (Tons/Hr):	20.55	22.32	22.12	21.66
Filterable Particulate Emissions				
Total Filterable PM, mg - Catch weight:	1.40	1.10	1.60	1.37
Emission Concentration, Gr./DSCF:	0.0004	0.0003	0.0005	0.0004
Emission Rate, Lbs./Hr:	0.22	0.17	0.26	0.22
Condensable PM, mg - Catch weight:	0.70	0.30	0.70	0.57
Emission Concentration, Gr./DSCF:	0.0002	0.0001	0.0002	0.0002
Emission Rate, Lbs./Hr:	0.11	0.05	0.11	0.09
Total PM, mg - Catch weight:	2.10	1.40	2.30	1.93
Emission Concentration, Gr./DSCF:	0.00065	0.0004	0.00072	0.0006
Emission Rate, Lbs./Hr:	0.33	0.22	0.37	0.31

TABLE 9
SUMMARY OF TEST RESULTS
Vent ID SVE-BH –NO_x, CO & VOC Emission Testing

	1	2	3	Averages
Run Number:	1	2	3	
Date:	5/1/2019	5/1/2019	5/1/2019	
Start Time:	11:10	13:55	18:47	
End Time:	12:13	14:55	19:47	
TT - Sampling Time:	63	60	60	
%M - Percent Moisture:	2.12	2.23	2.14	2.16
%CO ₂ - Carbon Dioxide, Dry:	0.00	0.00	0.00	0.00
%O ₂ - Oxygen, Dry:	20.87	20.86	20.93	20.89
Qa - Stack Gas Volume (ACFM):	67,887	72,979	66,621	69,162
Qstd - Stack Gas Volume (DSCFM):	59,967	64,589	59,990	61,515
Qstd - Stack Gas Volume (DSCFH):	3,598,028	3,875,322	3,599,409	3,690,920
<u>Production Data</u>				
Tons of Metal Melted (Tons/Hr):	20.55	22.32	22.12	21.66
<u>Emission Results</u>				
NO _x , ppm =	0.00	0.00	0.00	0.00
NO _x , lbs./hr =	0.00	0.00	0.00	0.00
CO, ppm =	9.34	7.73	2.64	6.57
CO, lbs./hr =	2.44	2.18	0.69	1.77
CO, lbs./Ton=	0.12	0.10	0.03	0.08
THC, ppm =	7.16	5.52	3.19	5.29
THC, lbs./hr =	2.95	2.45	1.32	2.24
THC, lbs./Ton =	0.14	0.11	0.06	0.10

TABLE 10
SUMMARY OF TEST RESULTS
Vent ID SVF-BH – Particulate Emission Testing

	1	2	3	Averages
Run Number:				
Date:	4/30/2019	4/30/2019	4/30/2019	
Start Time:	9:00	13:07	19:53	
End Time:	10:03	14:09	20:55	
A - Stack Area, SQ.FT:	18.99	18.99	18.99	
CP - Pitot Coefficient:	0.83	0.83	0.83	0.83
Y - Meter Calibration Factor:	0.9998	0.9998	0.9998	1.00
DN - Nozzle Diameter:	0.216	0.216	0.216	0.216
Pbar - Barometric Pressure:	28.75	28.75	28.82	28.77
TT - Sampling Time:	60	60	60	60
VM - Meter Volume:	51.190	47.557	49.649	49.465
VMSTD - Std. Gas Volume (SCF):	51.351	47.028	49.742	49.374
PIT - Avg. Delta P (in. of H2O):	1.138	0.968	1.057	1.054
PM - Avg. Delta H (in. of H2O):	2.388	2.031	2.220	2.21
TS - Stack Temp. (F):	101	95	94	97
TM - Avg. Meter Temp(F):	49	55	50	51
Vlc - Volume Water Collected:	36	16.5	25	26
VWSTD - Std. Water Volume (SCF):	1.696	0.777	1.178	1.217
%M - Percent Moisture:	3.20	1.63	2.31	2.38
Bws - Mole Fraction, Dry:	0.032	0.016	0.023	0.0238
%CO2 - Carbon Dioxide, Dry:	0.08	0.04	0.00	0.04
%O2 - Oxygen, Dry:	20.81	20.77	20.90	20.83
MD - Dry Molecular Weight:	28.85	28.84	28.84	28.84
MS - Wet Molecular Weight:	28.50	28.66	28.59	28.58
PS - Stack Press. (in. of Hg):	28.68	28.68	28.77	28.71
VS - Stack Gas Velocity (AFPS):	62.3	56.9	59.4	59.53
Qstd - Stack Gas Volume (DSCFM):	61,986	58,111	60,612	60,236
QA - Stack Gas Volume (ACFM):	70,987	64,769	67,674	67,810
QS - Stack Gas Velocity (SCFM):	64,033	59,071	62,047	61,717
%I - Isokinetic Ratio:	103.1	100.7	102.1	102.0
<u>Filterable Particulate Emissions</u>				
Total Filterable PM, mg - Catch weight:	1.90	0.90	1.20	1.33
Emission Concentration, Gr./DSCF:	0.0006	0.0003	0.0004	0.0004
Emission Rate, Lbs./Hr:	0.30	0.15	0.19	0.21
Condensable PM, mg - Catch weight:	1.50	0.30	0.40	0.73
Emission Concentration, Gr./DSCF:	0.00045	0.00010	0.00012	0.00022
Emission Rate, Lbs./Hr:	0.24	0.05	0.06	0.12
Total PM, mg - Catch weight:	3.40	1.20	1.60	2.07
Emission Concentration, Gr./DSCF:	0.00102	0.00039	0.00050	0.00064
Emission Rate, Lbs./Hr:	0.54	0.20	0.26	0.33

TABLE 11
SUMMARY OF TEST RESULTS
Vent ID SVG-BH – Particulate Emission Testing

	1	2	3	Averages
Run Number:				
Date:	4/30/2019	4/30/2019	4/30/2019	
Start Time:	9:00	13:07	19:53	
End Time:	10:02	14:08	20:55	
A - Stack Area, SQ.FT:	13.10	13.10	13.10	
CP - Pitot Coefficient:	0.84	0.84	0.84	0.84
Y - Meter Calibration Factor:	1.0050	1.0050	1.0050	1.01
DN - Nozzle Diameter:	0.213	0.213	0.213	0.213
Pbar - Barometric Pressure:	28.81	28.87	28.82	28.83
TT - Sampling Time:	60	60	60	60
VM - Meter Volume:	44.890	44.420	46.404	45.238
VMSTD - Std. Gas Volume (SCF):	46.009	44.682	46.906	45.866
PIT - Avg. Delta P (in. of H2O):	0.949	0.922	0.988	0.953
PM - Avg. Delta H (in. of H2O):	1.904	1.843	2.011	1.92
TS - Stack Temp. (F):	93	100	95	96
TM - Avg. Meter Temp(F):	41	51	48	47
Vlc - Volume Water Collected:	28	40	30	33
VWSTD - Std. Water Volume (SCF):	1.319	1.884	1.413	1.539
%M - Percent Moisture:	2.79	4.05	2.92	3.25
Bws - Mole Fraction, Dry:	0.028	0.040	0.029	0.0325
%CO2 - Carbon Dioxide, Dry:	0.00	0.03	0.00	0.01
%O2 - Oxygen, Dry:	20.74	20.73	20.90	20.79
MD - Dry Molecular Weight:	28.83	28.83	28.84	28.83
MS - Wet Molecular Weight:	28.53	28.40	28.52	28.48
PS - Stack Press. (in. of Hg):	28.77	28.84	28.78	28.79
VS - Stack Gas Velocity (AFPS):	57.3	56.9	58.6	57.59
Qstd - Stack Gas Volume (DSCFM):	40,167	38,979	40,893	40,013
QA - Stack Gas Volume (ACFM):	45,004	44,694	46,042	45,247
QS - Stack Gas Velocity (SCFM):	41,318	40,623	42,125	41,355
%I - Isokinetic Ratio:	101.1	101.2	101.2	101.2
<u>Filterable Particulate Emissions</u>				
Total Filterable PM, mg - Catch weight:	3.80	2.70	1.60	2.70
Emission Concentration, Gr./DSCF:	0.0013	0.0009	0.0005	0.0009
Emission Rate, Lbs./Hr:	0.44	0.31	0.18	0.31
Condensable PM, mg - Catch weight:				
Emission Concentration, Gr./DSCF:	0.0002	0.0001	0.0003	0.0002
Emission Rate, Lbs./Hr:	0.07	0.03	0.10	0.07
Total PM, mg - Catch weight:				
Emission Concentration, Gr./DSCF:	0.0015	0.0010	0.0008	0.0011
Emission Rate, Lbs./Hr:	0.51	0.35	0.29	0.38

TABLE 12
SUMMARY OF TEST RESULTS
Vent ID SVHJ-BH – Particulate Emission Testing

	1	2	3	Averages
Run Number:	1	2	3	
Date:	5/2/2019	5/2/2019	5/2/2019	
Start Time:	7:55	9:24	10:52	
End Time:	9:01	10:28	12:18	
A - Stack Area, SQ.FT:	69.64	69.64	69.64	
CP - Pitot Coefficient:	0.83	0.83	0.83	0.83
Y - Meter Calibration Factor:	1.0050	1.0050	1.0050	1.01
DN - Nozzle Diameter:	0.233	0.218	0.218	0.223
Pbar - Barometric Pressure:	28.65	28.65	28.65	28.65
TT - Sampling Time:	60	60	60	60
VM - Meter Volume:	50.035	44.098	43.872	46.002
VMSTD - Std. Gas Volume (SCF):	50.948	44.715	43.945	46.536
PIT - Avg. Delta P (in. of H2O):	0.778	0.782	0.768	0.776
PM - Avg. Delta H (in. of H2O):	2.344	1.800	1.769	1.97
TS - Stack Temp. (F):	70	70	70	70
TM - Avg. Meter Temp(F):	42	43	49	45
Vlc - Volume Water Collected:	12	8	8	9
VWSTD - Std. Water Volume (SCF):	0.565	0.377	0.377	0.440
%M - Percent Moisture:	1.10	0.84	0.85	0.93
Bws - Mole Fraction, Dry:	0.011	0.008	0.009	0.0093
%CO2 - Carbon Dioxide, Dry:	0.00	0.00	0.00	0.00
%O2 - Oxygen, Dry:	20.90	20.90	20.90	20.90
MD - Dry Molecular Weight:	28.84	28.84	28.84	28.84
MS - Wet Molecular Weight:	28.72	28.75	28.74	28.74
PS - Stack Press. (in. of Hg):	28.61	28.61	28.61	28.61
VS - Stack Gas Velocity (AFPS):	50.2	50.3	49.9	50.11
Qstd - Stack Gas Volume (DSCFM):	197,551	198,606	196,819	197,659
QA - Stack Gas Volume (ACFM):	209,625	210,170	208,384	209,393
QS - Stack Gas Velocity (SCFM):	199,743	200,280	198,507	199,510
%I - Isokinetic Ratio:	101.2	100.9	100.0	100.7
<u>Filterable Particulate Emissions</u>				
Total Filterable PM, mg - Catch weight:	0.30	0.10	0.20	0.20
Emission Concentration, Gr./DSCF:	0.00009	0.00003	0.00007	0.00007
Emission Rate, Lbs./Hr:	0.15	0.06	0.12	0.11

TABLE 13
SUMMARY OF TEST RESULTS
Vent ID SVK-BH – Particulate Emission Testing

	1	2	3	Averages
Run Number:	1	2	3	
Date:	4/28/2019	4/28/2019	4/28/2019	
Start Time:	13:50	15:05	16:27	
End Time:	14:51	16:07	17:24	
A - Stack Area, SQ.FT:	6.31	6.31	6.31	
CP - Pitot Coefficient:	0.84	0.84	0.84	0.84
Y - Meter Calibration Factor:	0.9824	0.9824	0.9824	0.98
DN - Nozzle Diameter:	0.210	0.213	0.210	0.211
Pbar - Barometric Pressure:	28.82	28.8	28.81	28.81
TT - Sampling Time:	60	60	60	60
VM - Meter Volume:	57.004	59.062	56.641	57.569
VMSTD - Std. Gas Volume (SCF):	54.960	56.471	53.879	55.104
PIT - Avg. Delta P (in. of H2O):	1.296	1.283	1.238	1.272
PM - Avg. Delta H (in. of H2O):	2.796	2.949	2.723	2.82
TS - Stack Temp. (F):	74	72	69	72
TM - Avg. Meter Temp(F):	62	66	69	65
Vlc - Volume Water Collected:	12	7	5	8
VWSTD - Std. Water Volume (SCF):	0.565	0.330	0.236	0.377
%M - Percent Moisture:	1.02	0.58	0.44	0.68
Bws - Mole Fraction, Dry:	0.010	0.006	0.004	0.0068
%CO2 - Carbon Dioxide, Dry:	0.00	0.00	0.00	0.00
%O2 - Oxygen, Dry:	20.90	20.90	20.90	20.90
MD - Dry Molecular Weight:	28.84	28.84	28.84	28.84
MS - Wet Molecular Weight:	28.73	28.77	28.79	28.76
PS - Stack Press. (in. of Hg):	28.78	28.76	28.77	28.77
VS - Stack Gas Velocity (AFPS):	65.6	65.2	63.8	64.87
Qstd - Stack Gas Volume (DSCFM):	23,389	23,374	23,057	23,273
QA - Stack Gas Volume (ACFM):	24,822	24,664	24,137	24,541
QS - Stack Gas Velocity (SCFM):	23,630	23,511	23,158	23,433
%I - Isokinetic Ratio:	102.7	102.7	102.2	102.5
<u>Filterable Particulate Emissions</u>				
Total Filterable PM, mg - Catch weight:	0.80	0.10	0.10	0.33
Emission Concentration, Gr./DSCF:	0.00022	0.00003	0.00003	0.00009
Emission Rate, Lbs./Hr:	0.05	0.01	0.01	0.02

TABLE 14
SUMMARY OF TEST RESULTS
Vent ID SVL-BH – Particulate Emission Testing

	1	2	3	Averages
Run Number:	1	2	3	
Date:	5/2/2019	5/2/2019	5/2/2019	
Start Time:	11:42	12:55	14:07	
End Time:	12:43	13:56	15:08	
A - Stack Area, SQ.FT:	6.31	6.31	6.31	
CP - Pitot Coefficient:	0.84	0.84	0.84	0.84
Y - Meter Calibration Factor:	0.9824	0.9824	0.9824	0.98
DN - Nozzle Diameter:	0.213	0.213	0.213	0.213
Pbar - Barometric Pressure:	28.77	28.77	28.79	28.78
TT - Sampling Time:	60	60	60	60
VM - Meter Volume:	55.578	55.617	56.014	55.736
VMSTD - Std. Gas Volume (SCF):	54.383	53.929	54.201	54.171
PIT - Avg. Delta P (in. of H2O):	1.217	1.225	1.221	1.221
PM - Avg. Delta H (in. of H2O):	2.667	2.653	2.644	2.65
TS - Stack Temp. (F):	81	83	83	82
TM - Avg. Meter Temp(F):	53	58	59	57
Vlc - Volume Water Collected:	7	9	12	9
VWSTD - Std. Water Volume (SCF):	0.330	0.424	0.565	0.440
%M - Percent Moisture:	0.60	0.78	1.03	0.80
Bws - Mole Fraction, Dry:	0.006	0.008	0.010	0.0080
%CO2 - Carbon Dioxide, Dry:	0.00	0.00	0.00	0.00
%O2 - Oxygen, Dry:	20.90	20.90	20.90	20.90
MD - Dry Molecular Weight:	28.84	28.84	28.84	28.84
MS - Wet Molecular Weight:	28.77	28.75	28.72	28.75
PS - Stack Press. (in. of Hg):	28.73	28.73	28.75	28.73
VS - Stack Gas Velocity (AFPS):	64.0	64.3	64.2	64.19
Qstd - Stack Gas Volume (DSCFM):	22,537	22,558	22,473	22,523
QA - Stack Gas Volume (ACFM):	24,214	24,343	24,297	24,285
QS - Stack Gas Velocity (SCFM):	22,674	22,735	22,707	22,705
%I - Isokinetic Ratio:	102.5	101.6	102.5	102.2
<u>Filterable Particulate Emissions</u>				
Total Filterable PM, mg - Catch weight:	0.10	0.10	0.10	0.10
Emission Concentration, Gr./DSCF:	0.00003	0.00003	0.00003	0.00003
Emission Rate, Lbs./Hr:	0.01	0.01	0.01	0.01

TABLE 15
SUMMARY OF TEST RESULTS
Facility Visible Emission Testing

TEST RUN 1

Date: 4/29/19
Start Time: 7:55
End Time: 9:07

	Average
Minutes	% Opacity
1-6	0.21
7-12	0.42
13-18	0.21
19-24	0.21
25-30	0.21

	Average
Minutes	% Opacity
31-36	0.42
37-42	0.21
43-48	0.42
49-54	0.21
55-60	0.21

TEST RUN 2

Date: 4/29/19
Start Time: 10:15
End Time: 11:19

	Average
Minutes	% Opacity
1-6	0.42
7-12	0.63
13-18	0.63
19-24	1.04
25-30	0.63

	Average
Minutes	% Opacity
31-36	0.21
37-42	0.63
43-48	0.42
49-54	0.21
55-60	0.63

TEST RUN 3

Date: 4/29/19
Start Time: 12:20
End Time: 13:24

	Average
Minutes	% Opacity
1-6	0.42
7-12	0.42
13-18	0.21
19-24	0.42
25-30	0.21

	Average
Minutes	% Opacity
31-36	0.21
37-42	0.21
43-48	0.21
49-54	0.63
55-60	0.21

SOURCE DIAGRAMS AND TRAVERSE POINT IDENTIFICATION

FIGURE 1
VENT IDS SVAB-BH & SVHJ-BH
Exhaust Stack Dimensions

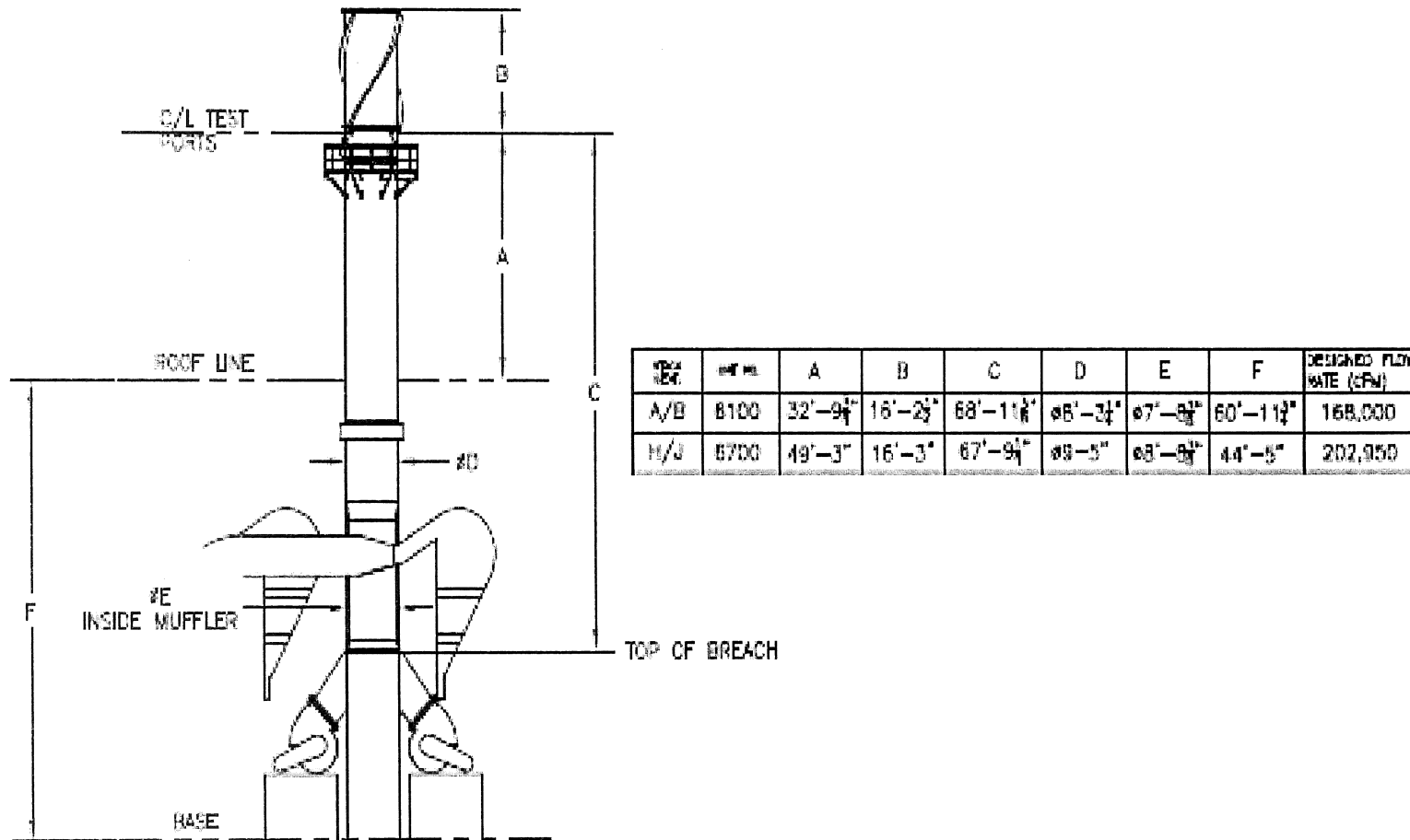
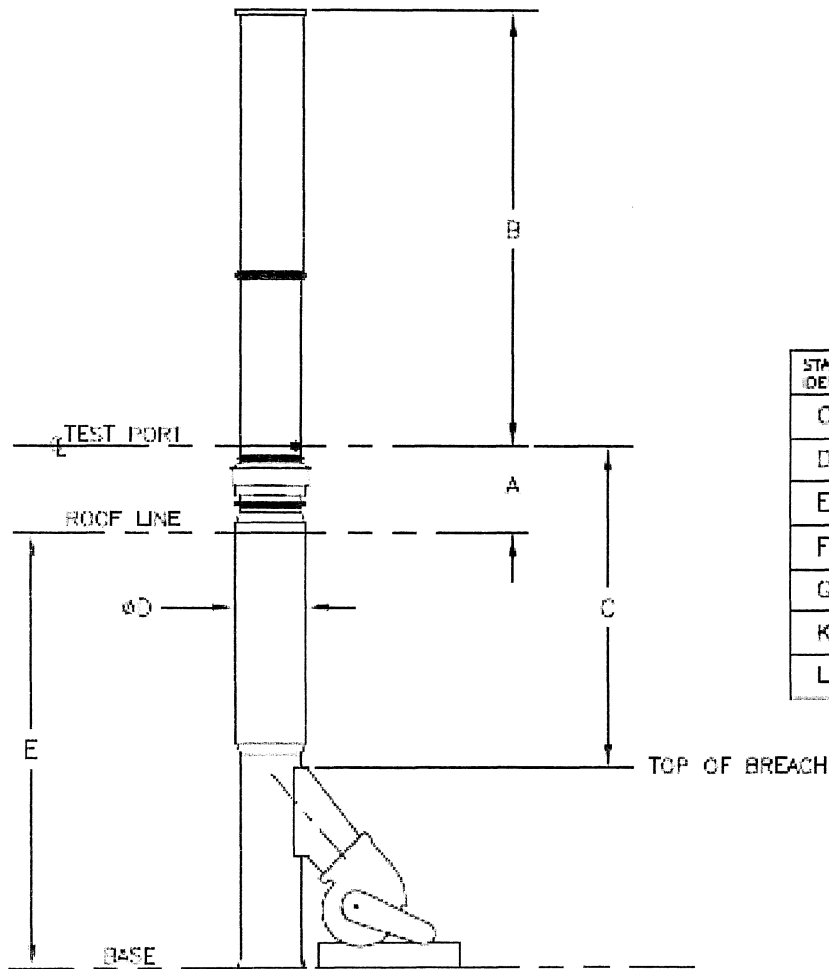
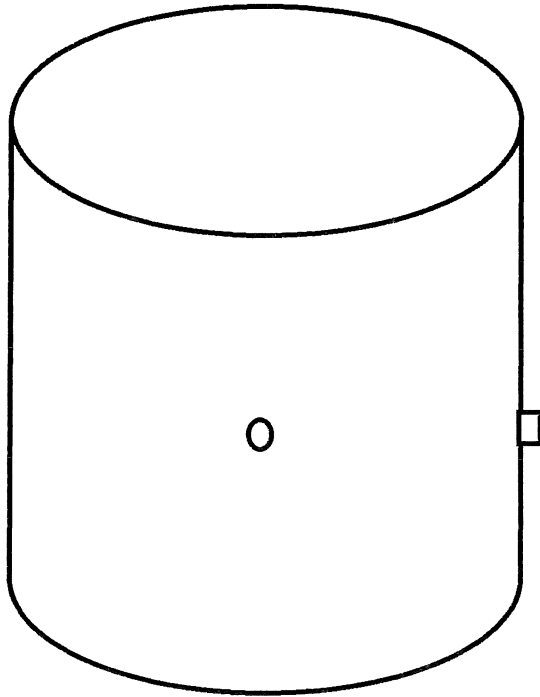

FIGURE 2
VENT IDs SVC-BH, SVD-BH, SVE-BH, SVF-BH, SVG-BH, SVK-BH & SVL-BH
Exhaust Stack Dimensions



STACK IDENT.	UNIT NO.	A	B	C	D	E	DESIGNED FLOW RATE (CFM)
C	6600	3'-9"	40'-2"	28'-1 $\frac{1}{16}$ "	ø6'-7"	111'-1"	105,000
D	6200	3'-9 $\frac{1}{2}$ "	40'-2"	29'-9 $\frac{1}{4}$ "	ø5'-9"	111'-1"	84,000
E	6300	3'-5 $\frac{1}{4}$ "	41'-8 $\frac{1}{4}$ "	19'-5 $\frac{2}{3}$ "	4'-11"	110'-6"	63,550
F	6400	3'-5 $\frac{3}{4}$ "	41'-8 $\frac{1}{4}$ "	19'-5 $\frac{2}{3}$ "	4'-11"	110'-6"	64,000
G	6500	3'-7 $\frac{1}{2}$ "	41'-0"	20'-11 $\frac{1}{8}$ "	ø4'-1"	110'-4"	42,000
K	6800	2'-0"	22'-4 $\frac{1}{4}$ "	20'-8 $\frac{1}{8}$ "	ø2'-10"	161'-1"	21,000
L	6900	2'-4"	21'-2 $\frac{3}{4}$ "	23'-3 $\frac{3}{8}$ "	ø2'-10"	148'-2"	21,000

FIGURE 3
VENT ID SVAB-BH
Traverse Point Identification



Exhaust Stack Specifications

99.25" Diameter

Two test Ports

Disturbance to Ports Distance

Upstream = 1.96 Diameters

Downstream = 8.33 Diameters

Particulate Sampling	
Traverse Points	Measurements
1	4.36"
2	14.49"
3	29.38"
4	69.87"
5	84.76"
6	94.88"

Instrumental Sampling	
Traverse Points	Measurements
1	16.57"
2	49.62"
3	82.67"

FIGURE 4
VENT ID SVC-BH
Traverse Point Identification

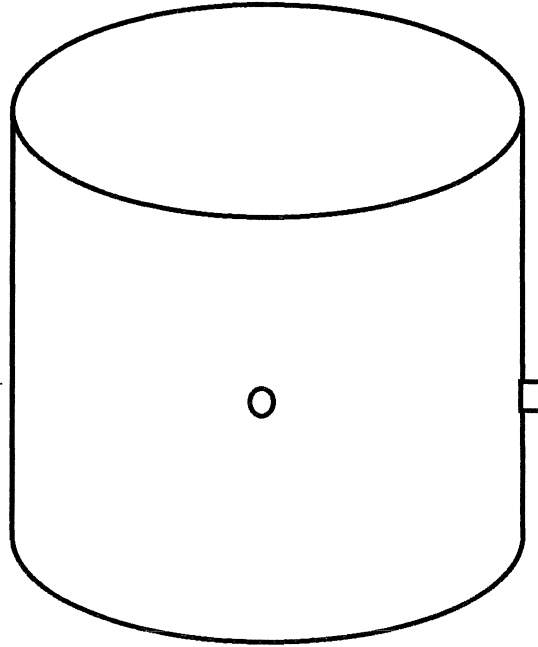

Exhaust Stack Specifications

79" Diameter
 Two test Ports

Disturbance to Ports Distance

Upstream = 6.10 Diameters
 Downstream = 4.27 Diameters

Particulate Sampling	
Traverse Points	Measurements
1	1.66"
2	5.29"
3	9.32"
4	13.98"
5	19.75"
6	28.12"
7	50.88"
8	59.25"
9	65.02"
10	69.68"
11	73.71"
12	77.34"

Instrumental Sampling	
Traverse Points	Measurements
1	13.19"
2	39.5"
3	65.80"

FIGURE 5
VENT ID SVD-BH
Traverse Point Identification

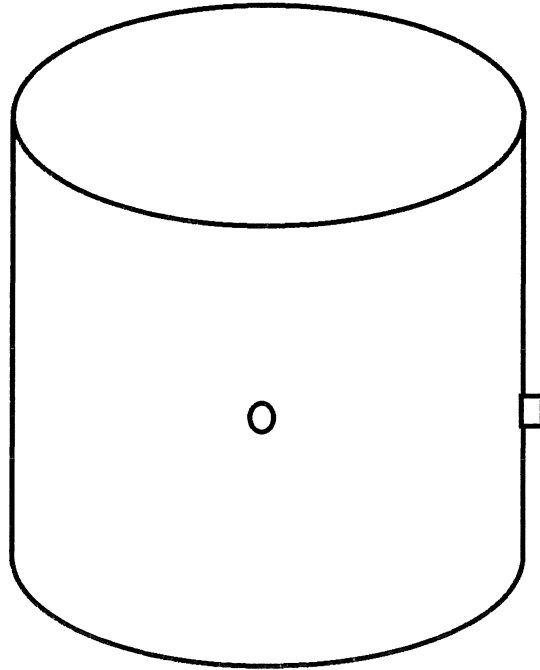

Exhaust Stack Specifications

69" Diameter
 Two test Ports

Disturbance to Ports Distance

Upstream = 6.99 Diameters
 Downstream = 5.18 Diameters

Particulate Sampling	
Traverse Points	Measurements
1	1.79"
2	5.66"
3	10.07"
4	15.59"
5	23.60"
6	45.40"
7	53.41"
8	58.93"
9	63.34"
10	67.21"

Instrumental Sampling	
Traverse Points	Measurements
1	11.52"
2	34.5"
3	57.47"

FIGURE 6
VENT ID SVE-BH
Traverse Point Identification

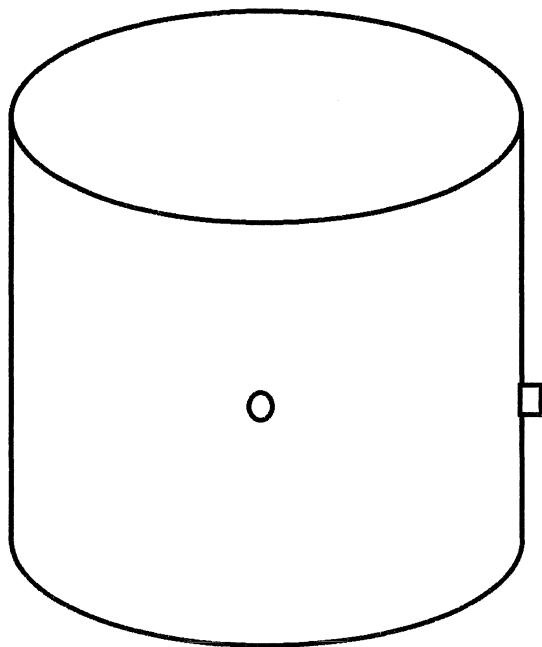

Exhaust Stack Specifications

59" Diameter
 Two test Ports

Disturbance to Ports Distance

Upstream = 8.48 Diameters
 Downstream = 3.96 Diameters

Particulate Sampling	
Traverse Points	Measurements
1	1.24"
2	3.95"
3	6.96"
4	10.44"
5	14.75"
6	21.00"
7	38.00"
8	44.25"
9	48.56"
10	52.04"
11	55.05"
12	57.76"

Instrumental Sampling	
Traverse Points	Measurements
1	9.85"
2	29.5"
3	49.14"

FIGURE 7
VENT ID SVF-BH
Traverse Point Identification

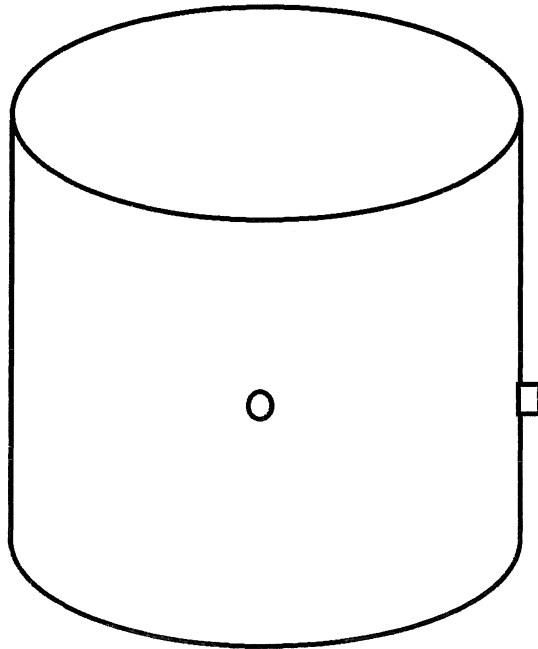

Exhaust Stack Specifications

59" Diameter
 Two test Ports

Disturbance to Ports Distance

Upstream = 8.48 Diameters
 Downstream = 3.96 Diameters

Particulate Sampling	
Traverse Points	Measurements
1	1.24"
2	3.95"
3	6.96"
4	10.44"
5	14.75"
6	21.00"
7	38.00"
8	44.25"
9	48.56"
10	52.04"
11	55.05"
12	57.76"

Instrumental Sampling	
Traverse Points	Measurements
1	9.85"
2	29.5"
3	49.14"

FIGURE 8
VENT ID SVG-BH
Traverse Point Identification

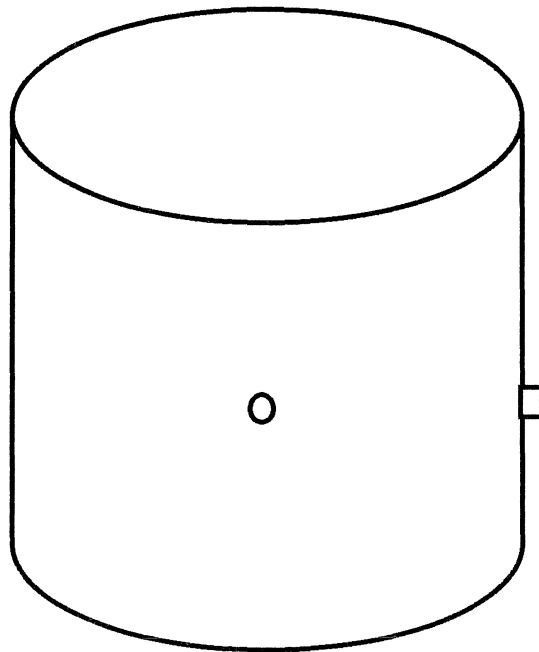

Exhaust Stack Specifications

49" Diameter
 Two test Ports

Disturbance to Ports Distance

Upstream = 10.04 Diameters
 Downstream = 5.14 Diameters

Particulate Sampling	
Traverse Points	Measurements
1	1.27"
2	4.02"
3	7.15"
4	11.07"
5	16.76"
6	32.24"
7	37.93"
8	41.85"
9	44.98"
10	47.73"

Instrumental Sampling	
Traverse Points	Measurements
1	8.18"
2	24.5"
3	40.81"

FIGURE 9
VENT ID SVHJ-BH
Traverse Point Identification

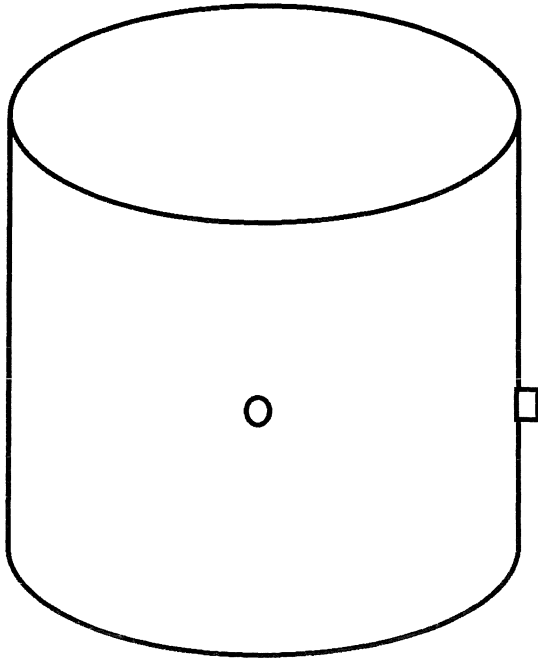

Exhaust Stack Specifications

113" Diameter
 Two test Ports

Disturbance to Ports Distance

Upstream = 1.73 Diameters
 Downstream = 7.20 Diameters

Particulate Sampling	
Traverse Points	Measurements
1	3.62"
2	11.87"
3	21.92"
4	36.50"
5	76.50"
6	91.08"
7	101.14"
8	109.38"

Instrumental Sampling	
Traverse Points	Measurements
1	18.87"
2	56.5"
3	94.12"

FIGURE 10
VENT ID SVK-BH
Traverse Point Identification

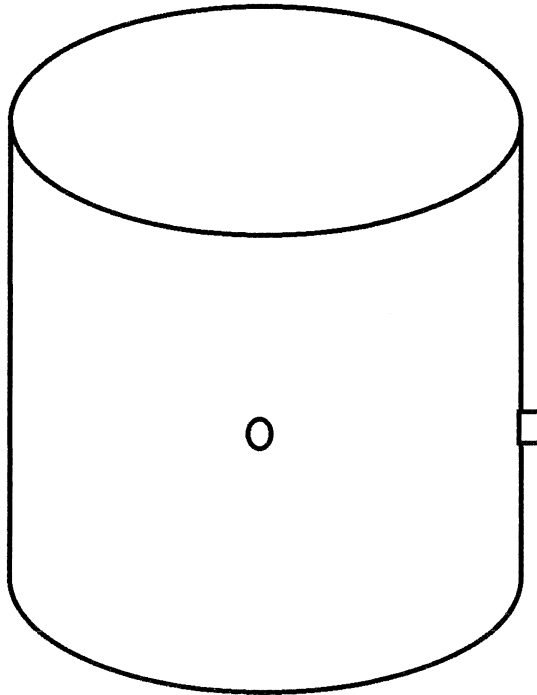

Exhaust Stack Specifications

34" Diameter
 Two test Ports

Disturbance to Ports Distance

Upstream = 7.90 Diameters
 Downstream = 7.30 Diameters

Particulate Sampling	
Traverse Points	Measurements
1	1.50"
2	4.96"
3	10.06"
4	23.94"
5	29.04"
6	32.50"

Instrumental Sampling	
Traverse Points	Measurements
1	5.67"
2	17"
3	28.32"

FIGURE 11
VENT ID SVL-BH
Traverse Point Identification

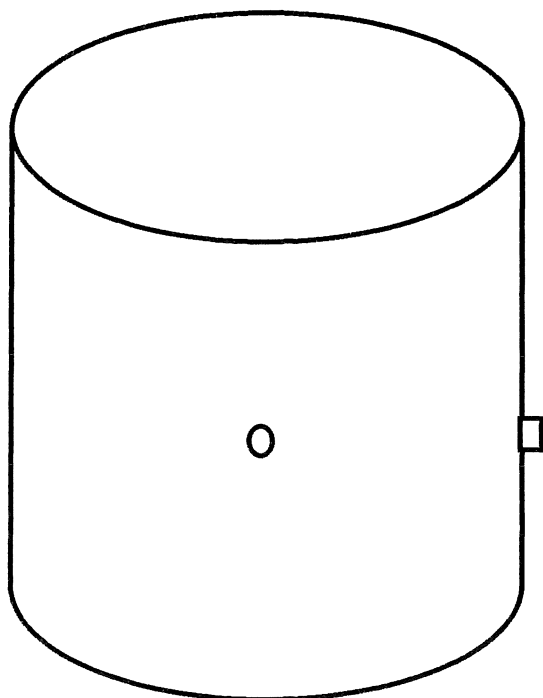

Exhaust Stack Specifications

34" Diameter
 Two test Ports

Disturbance to Ports Distance

Upstream = 7.49 Diameters
 Downstream = 8.21 Diameters

Particulate Sampling	
Traverse Points	Measurements
1	1.50"
2	4.96"
3	10.06"
4	23.94"
5	29.04"
6	32.50"

Instrumental Sampling	
Traverse Points	Measurements
1	5.67"
2	17"
3	28.32"

TEST METHOD SAMPLING SCHEMATICS

FIGURE 12
EPA Test Method 5 Sampling Schematic

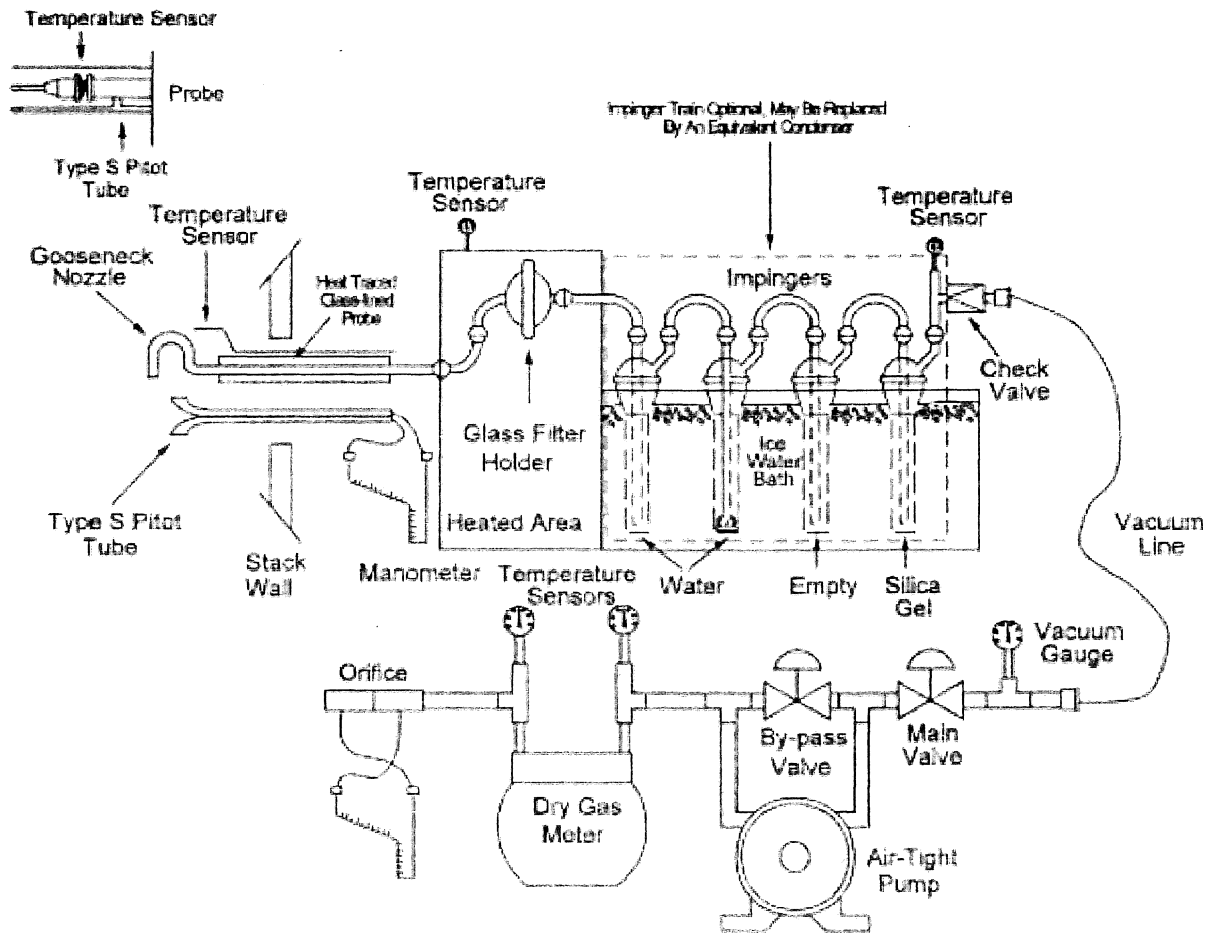

FIGURE 13
EPA Test Method 202 Sampling Schematic

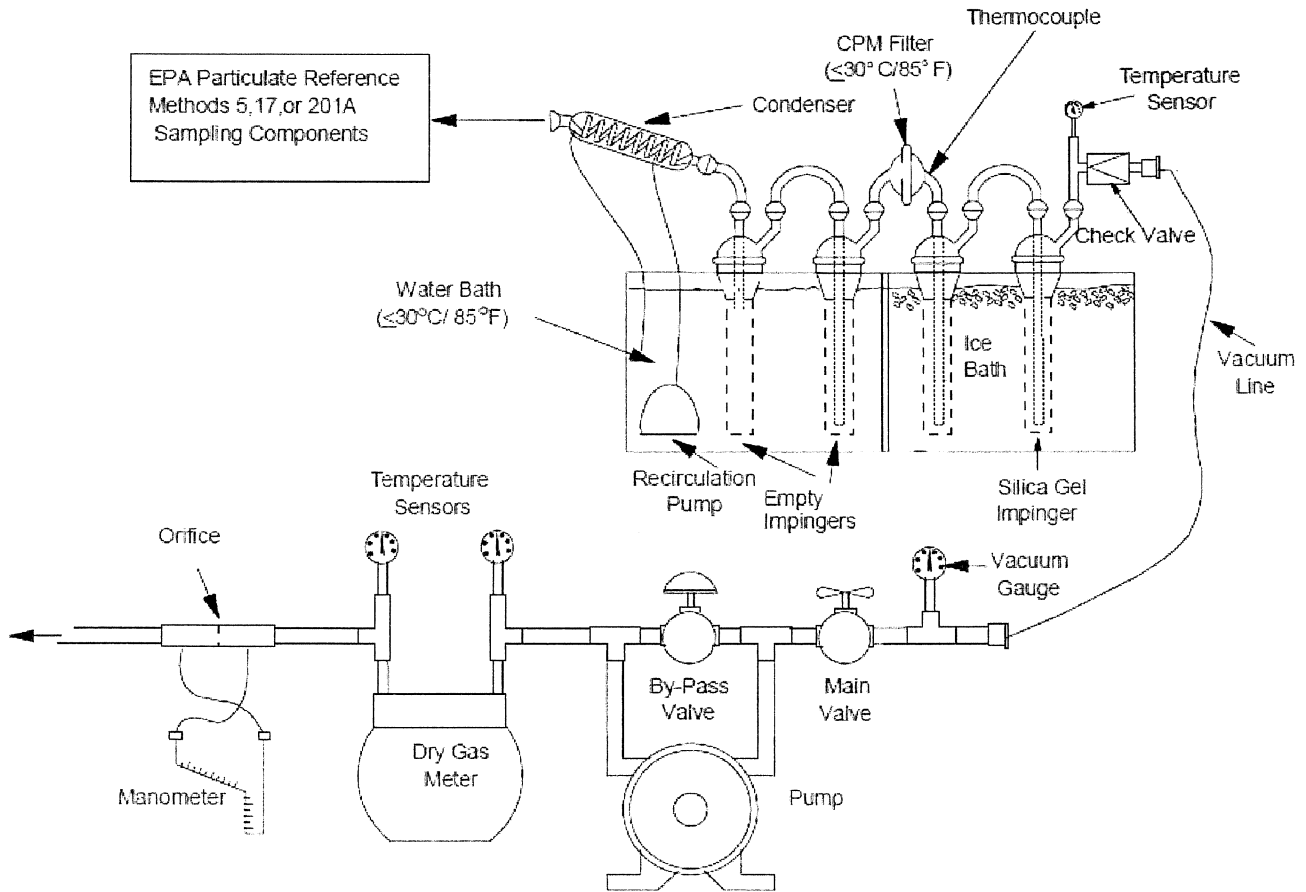

FIGURE 14

EPA Test Method 17 Sampling Schematic

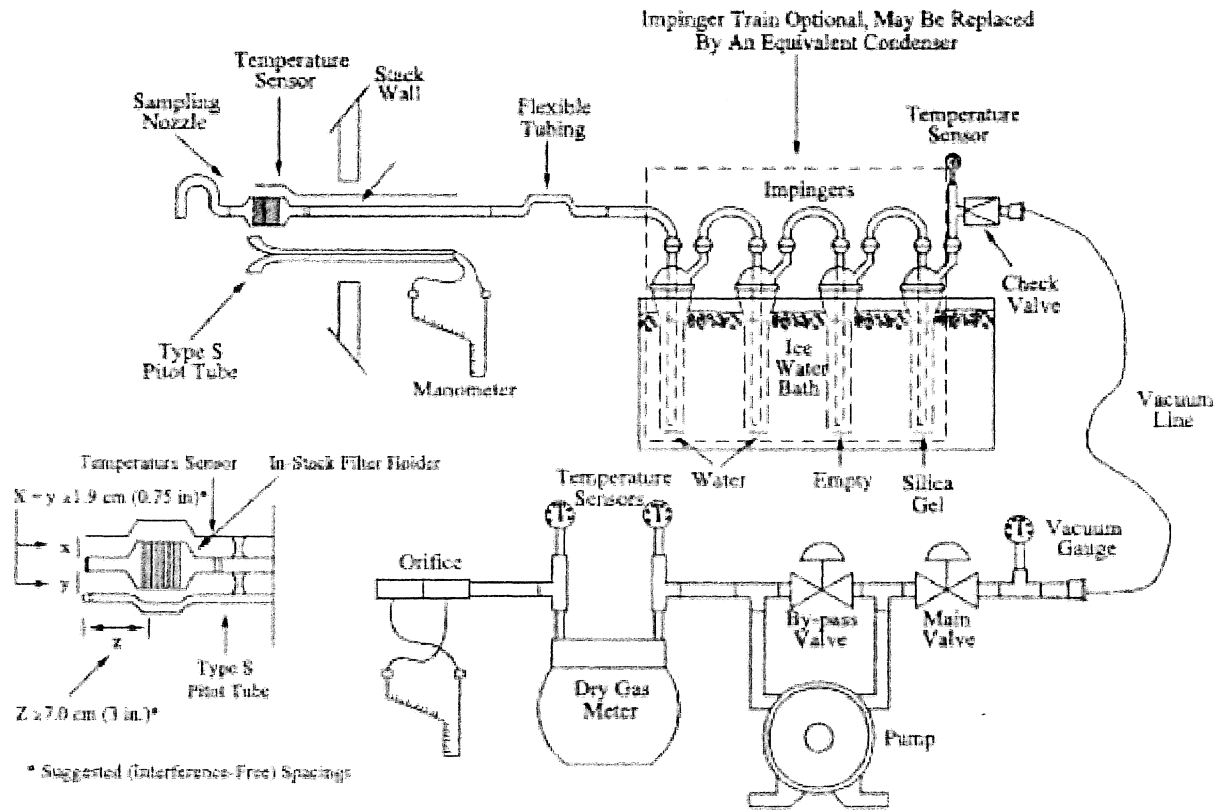

FIGURE 15

EPA Instrumental Test Methods 7E, 6C, 10 and 3A Sampling Schematic

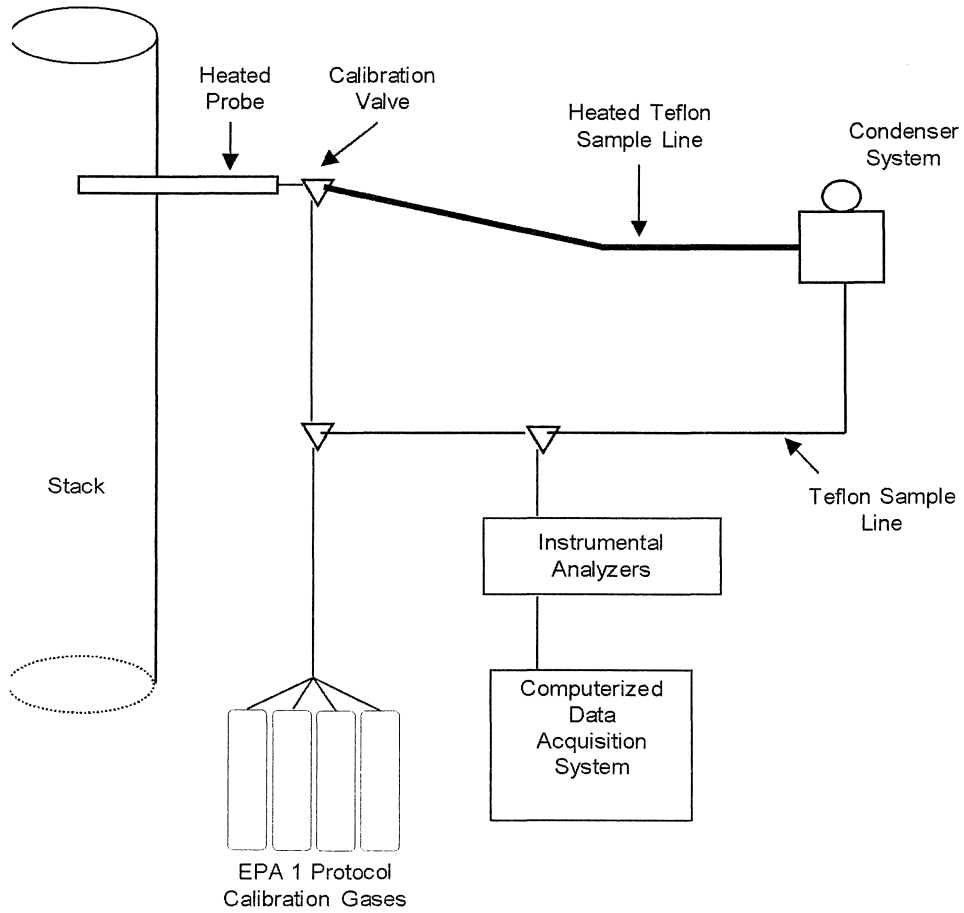

FIGURE 16
EPA Instrumental Test Method 25A Sampling Schematic

